



Modular Uninterruptible Power System

UPS5000-H- (400-1600 kVA) Series



INTRODUCTION

UPS5000-H is Huawei's medium and large-scale uninterruptible power supply system with advanced 100kVA/3U hot swappable power modules. The system achieves 1 MW, 1 rack, effectively saves footprint and installation time. System efficiency is up to 97%. Intelligent iPower improves system reliability and simplifies operation and maintenance for customers. The S-ECO mode achieves not only 99.1% high efficiency and optimal power quality but also 0ms mode transferring time.



100kVA/3U power modules



APPLICATION SCENARIOS

- Data centers in headquarter or disaster recovery data centers
- Internet data centers
- Large cloud computing data centers
- Critical power supply



UPS5000-H-400/500/600kVA



UPS5000-H-800kVA



UPS5000-H-1200kVA



UPS5000-H-1600kVA



Simple

- **Hot swappable** power module, bypass module and control module simplify maintenance and expansion in **5 minutes**
- Top bus way prefabricated design, reducing on-site installation time by **60%**



Green

- 1 MW, 1 rack, saving the footprint by **50%**
- Online mode: **97%** system efficiency, high efficiency at light-load
S-ECO mode: **99.1%** system efficiency, saving 140,000\$ in lifetime
- S-ECO mode **active filtering**, optimal power quality



Smart

- **iPower** pre-warnings for key components lifetime by AI method
- Source share of main and battery achieves **peak shaving**, **peak limiting** and **wider voltage range**



Reliable

- **Redundant** architecture eliminates single point of failure
- S-ECO mode: **0ms** mode transferring time.
- Bus bar temperature detection, display and alarm.

5 minutes

Simplify maintenance and expansion in

60%

Reduce on-site installation time by

50%

Saving the footprint by

97%

Online mode efficiency

99.1%

S-ECO mode efficiency

iPower

AI predictive maintenance

Source share mode

Peak shaving, intelligent current limiting and wider input voltage

Redundant architecture

0ms

Transferring time

SIMPLE

- **Hot swappable** power module, bypass module and control module simplify maintenance and expansion in **5 minutes**



Power module



Bypass module



System control module



LCD module

- Top bus way prefabricated design, reducing on-site installation time by **60%**

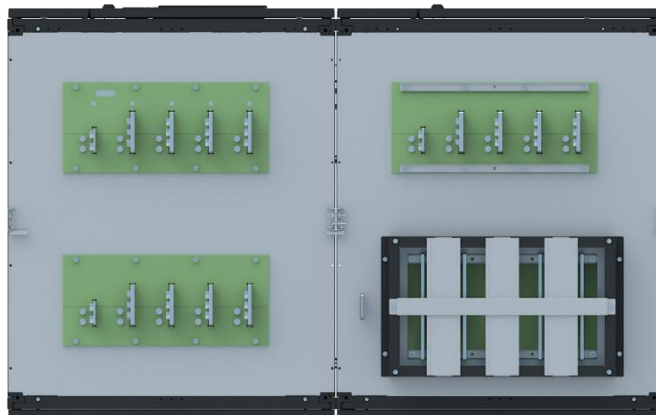

GREEN

- 1 MW, 1 rack, saving the footprint by **50%**

Capacity	D*W*H(mm)
400/500/600kVA	1000*800*2000
800kVA	1000*1600*2000
1200kVA	1000*1600*2200
1600kVA	1000*2400*2200

- Online mode: Up to **97%** system efficiency, high efficiency at light-load
- S-ECO mode: Up to **99.1%** system efficiency, **> 98.5% at 20%-100% load**, saving 70,000\$ in lifetime

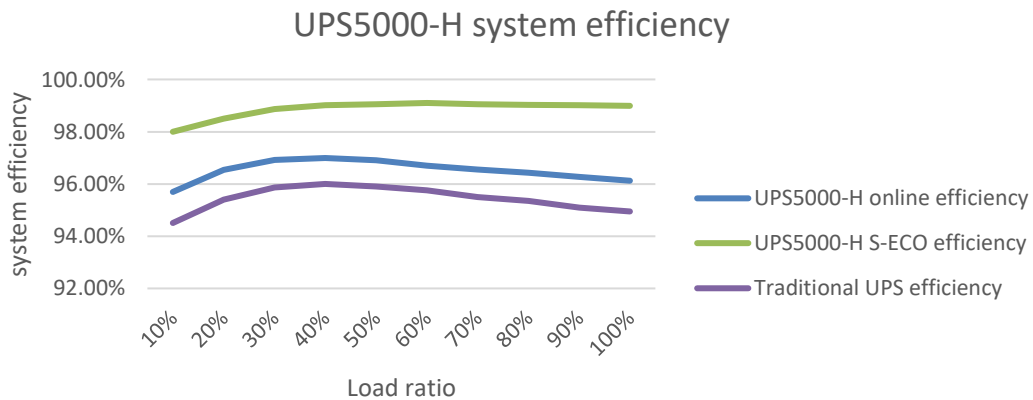

- S-ECO mode **active filtering**, optimal power quality

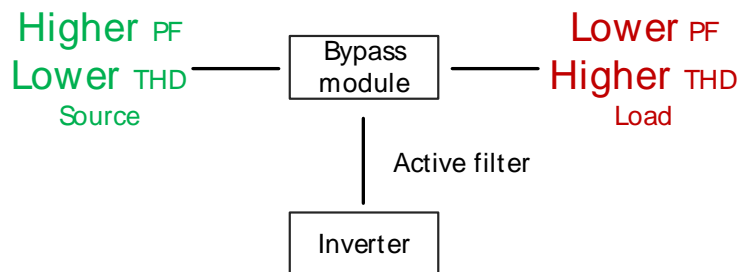

SMART

- **iPower** pre-warnings for key components by **AI method**

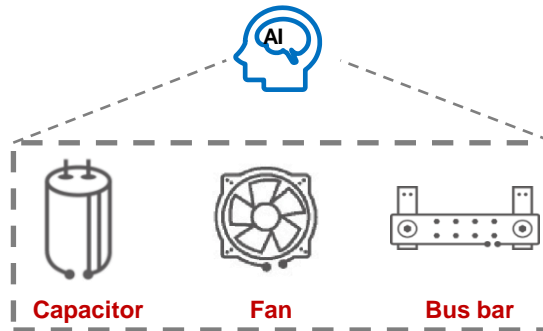

- **Source share** of main and battery achieves intelligent peak shaving, peak limiting and wider input voltage range.

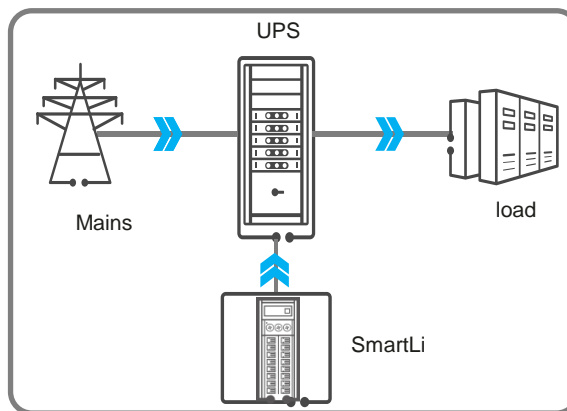

The battery provides up to 15% rated power

SMART

- Source share scenario 1: **Peak shaving**

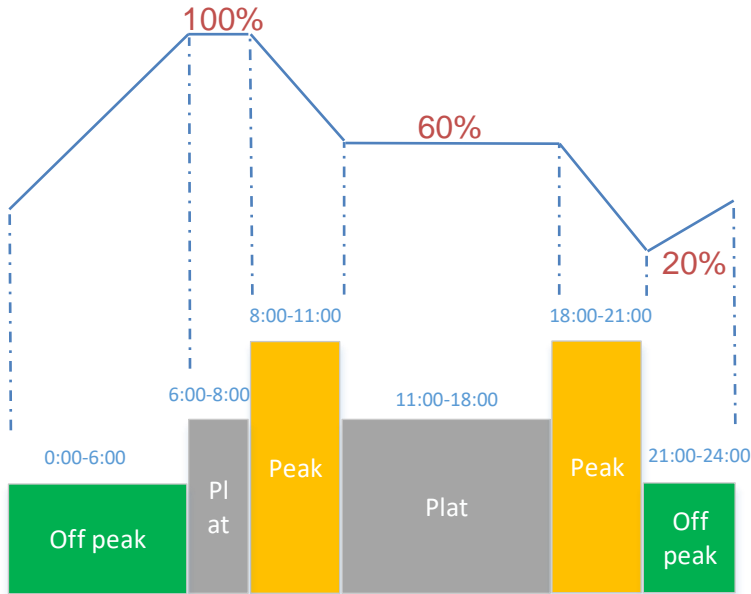

- **4000 times** life cycle supports one peak clipping cycle every day.
- The battery provides **15% rated power** during peak shaving.
- **One-click import** supports for quick configuration.

- Source share scenario 2: **Peak limiting**

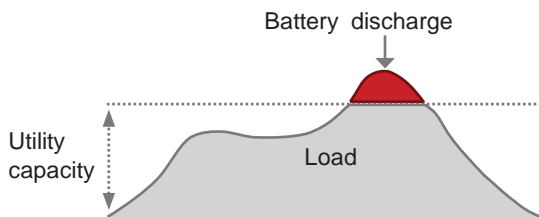

- **Settable** limiting value
- **No interruption** between mode transferring

- Source share scenario 3: **Wider voltage range**

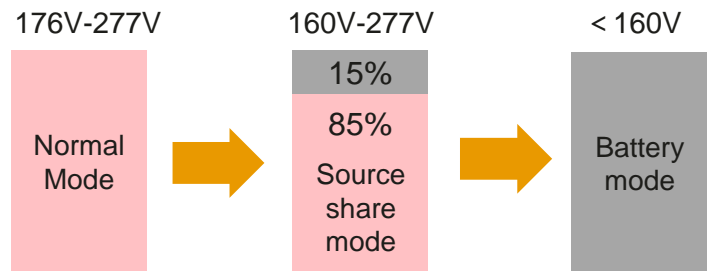

- 160V-277V input voltage range at full load (-25%)
- 80V-277V input voltage range at half load (-65%)

RELIABLE

- Redundant architecture eliminates single point of failure

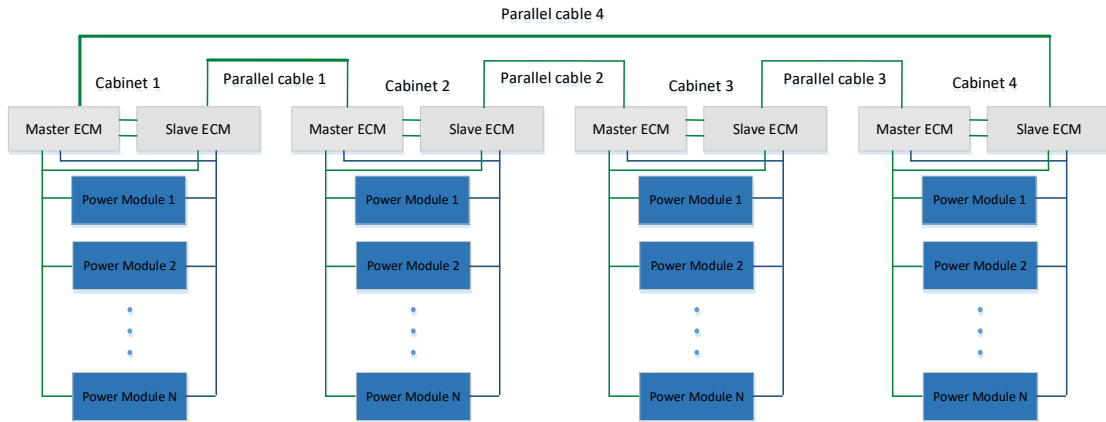

- S-ECO mode: **0ms** mode transferring time with hot backup component.

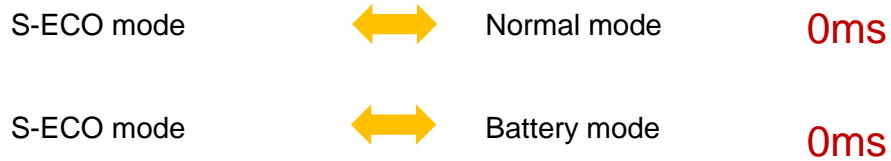
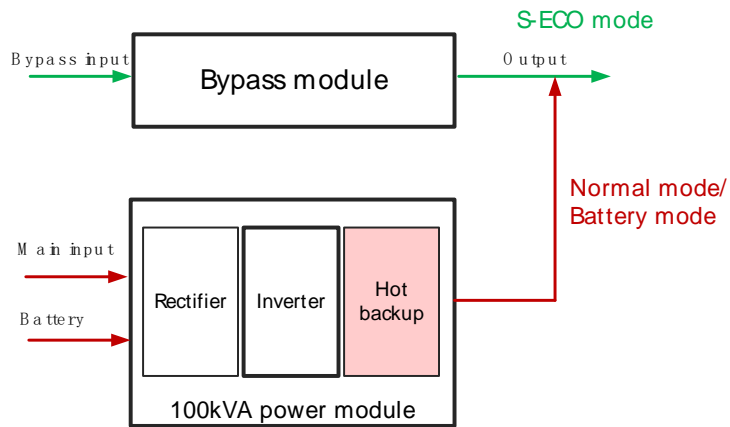

- Imbalance current of power module < 3% to get high reliability

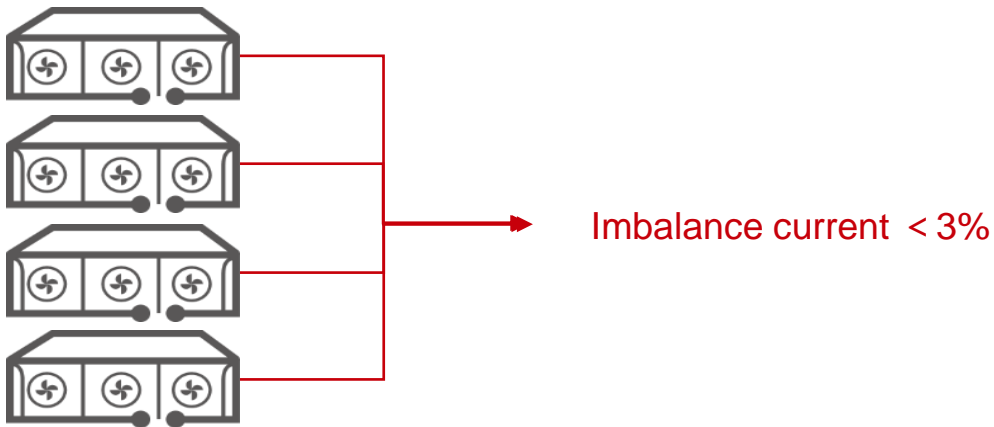

- Imbalance current of parallel system bypass mode < 10% (patented technology)

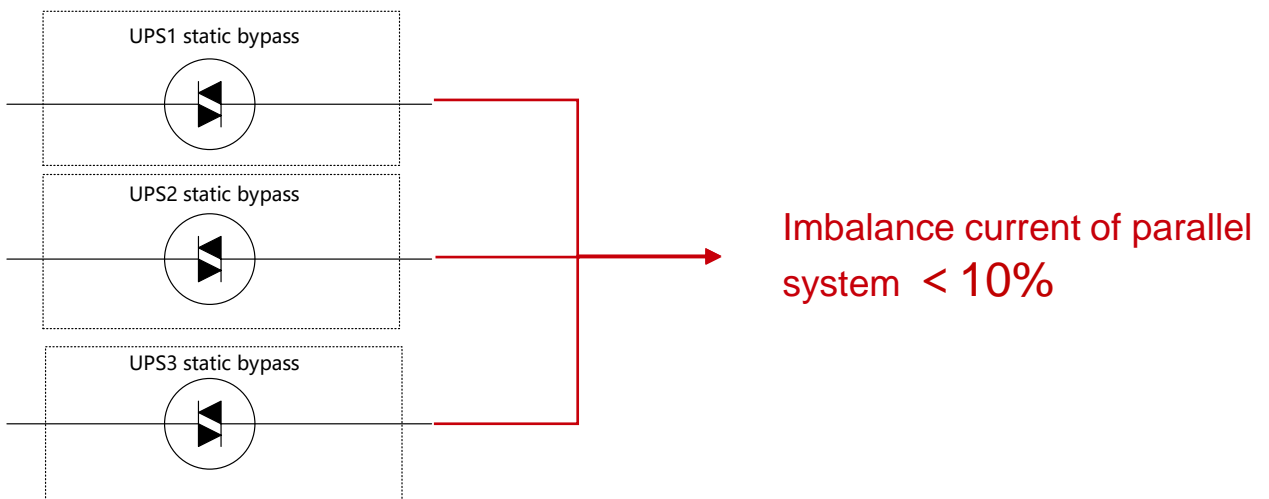

- Keep operating in high ambient temperature











Traditional UPS shut down when ambient temperature > 40°C

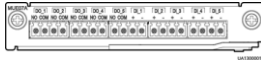

Huawei UPS automatically derating when temperature is 40°C-55°C

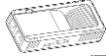
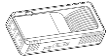

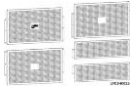
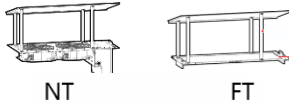
Optional accessory

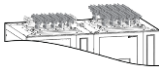
Optional Accessories	Appearance	Function
Dry contact expansion card		Provides monitoring extension ports, including five relay output ports and five input ports.
Backfeed protection card		Provides backfeed detection and protection for main and bypass.
Intelligent detection card		Check the temperature of the cable terminals of the switch cabinet and the status of each switch when the switch cabinet is optional.
Lightning protection box		The surge protection capability of the UPS is improved.
Ambient temperature and humidity sensor		Monitor the temperature and humidity of the environment.
Battery temperature sensor		Used for battery temperature detection.
Side cabinet of bottom entry		Used in the scenario where the cable is routed bottom.
Rear copper bar protection option		Protects the copper bar at the rear of the cabinet.
Top air exhaust assembly (600 kVA/800 kVA)		Used in the top air exhaust scenario. (Except NTR)
Top air exhaust assembly (1200/1600 kVA)		Used in the top air exhaust scenario.
Couple inductor cabinet		The 3P3W system is realized by configuring the inductor cabinet.
Cable connection assembly (1200/1600 kVA)		Used to connect cables for 1200 kVA/1600 kVA models.

SPECIFICATIONS 380V/400V/415V

Model		UPS5000-H-400/500/600k-NTR/NT/FT	UPS5000-H-800k-NT	UPS5000-H-1200k-NT	UPS5000-H-1600k-NT
Capacity	Rack Capacity	400/500/600kVA	800kVA	1200kVA	1600kVA
	Module number	2-4/2-5/2-6	2-8	2-12	2-16
Mains Input	Wiring	3Ph+N+PE			
	Rated Voltage	380/400/415Vac			
	Rated Frequency	50/60Hz			
	Connection	Single or dual input			
	Voltage Range	138-485Vac (100% load: 323-485V)			
	Frequency Range	40-70Hz			
	Total Harmonic Distortion	Normal mode: THDi<3% for 100% linear load S-ECO mode: THDi<3% for 100% linear load			
Power Factor	Normal mode: 0.99 S-ECO mode: 0.99				
Bypass Input	Wiring	3Ph+N+PE			
	Rated Voltage	380/400/415Vac			
	Rated Frequency	50/60Hz			
	Frequency range	±6Hz (Programmable, 0.5-6Hz, default±2Hz)			
	Synchronized slew rate (Hz/sec)	0.1Hz/s~2Hz/s, default 0.6Hz/s			
Battery	Battery Category	SmartLi, VRLA			
	Rated Voltage	VRLA: 360-600Vdc (The number of VRLA can be selected from 30 to 50; 40 batteries rated, no battery neutral, support odd battery number); SmartLi: 512Vdc			
	Battery parallel string	1-12			
	Maximum charge capacity and current	Single power module: 15%, 30A			
	Temperature compensation	0~6mV/°C			
	Battery sharing	Support			
Output	Wiring	3Ph+N+PE			
	Rated Voltage	380/400/415Vac			
	Voltage Regulation	±1%			
	Frequency	Tracking the bypass input (Normal mode); 50/60Hz±0.05% (Battery mode)			
	THDv	THDv<1% for linear load, THDv<3% for non linear load			
	Overload Capacity	Inverter: 100% < load≤110% for 60 minutes, then transfer to bypass mode; 110% < load≤125% for 10 minutes, then transfer to bypass mode; 125% < load≤150% for 1 minute, then transfer to bypass mode			
	Imbalance ratio	Voltage imbalance: 3%; Phase imbalance: ±1° (100% imbalance load)			
	Inverter short circuit	200%			
	Dynamic response	±5% (20ms recovery duration)			
	Power Factor	1			
	Power Factor range	0.5 leading to 0.5 lagging without derating			

Note: * The efficiency of the UPS system is the test result under typical working conditions, and it varies under different working conditions, and is subject to the actual use

The UPS5000 does not support energy feedback loads, such as elevators, medical CT machines, semiconductor cutting machines, and other motor loads that use energy feedback inverters.

SPECIFICATIONS 380V/400V/415V

Model		UPS5000-H-400/500/600k-NTR/NT/FT	UPS5000-H-800k-NT	UPS5000-H-1200k-NT	UPS5000-H-1600k-NT
Capacity	Rack Capacity	400/500/600kVA	800kVA	1200kVA	1600kVA
	Module number	2-4/2-5/2-6	2-8	2-12	2-16
System	Topology	Three level of IGBT double conversion			
	Icw (kA)	35	35	65	65
	Heat dissipation(kW)	21.7/23.6/28.3	43.3	56.6	75.4
	Heat dissipation(BTU/h)	73977/92472/110967	147955	221933	295910
	Color	RAL9005			
	Efficiency	Normal mode: Up to 97% * S-ECO mode: Up to 99.1%			
	Heat Dissipation Mode	Built-in fan for heat dissipation. Front-to-back exhaust by default.			
	Cable entry	Top in top output			
	Source share mode	Support main input and battery source sharing			
	Dust proof	Dustproof cotton in the front door			
	Battery cold start	Support			
	Remote EPO	Support			
	Parallel	6	4	4	2
Display	LCD screen	7 inch touchable screen			
	Indicator	Status indicators on the power module, bypass module, and monitoring module.			
	Display	Load rate, battery capacity percentage, and remaining backup time			
Optional accessory	BCB box	PDU8000 battery circuit break			
	Cable connection	/	/	Support	Support
	Bottom cable entry	Support bottom cable entry (except for the NTR)			
	Top air exhausting component	Support	Support(Side cabinet)		
	Lightning protection box	Optional 5kA (only NT, FT)	Optional 5kA	Standard 5kA	
	Back feed protection card	Support main and bypass back feed protection			
	Dry contact expansion card	5 DI and 5 DO ports			
	Couple inductor cabinet	/	Support 3P3W input	Support 3P3W input	Support 3P3W input
Environment	Operating Temperature	0-55°C,0-40°C no derating, 40-55°C with derating			
	Storage Temperature	-40-70°C			
	Protection level	IP20			
	Relative Humidity	0%-95% (No condensing)			
	Operating Altitude	0-2000m. Above 2000m, derating based on EN/IEC 62040-3			
Others	Weigh(kg)	NTR 615/670/725 NT 690/745/800 FT 750/805/860	1300kg	1600kg	2300kg
	Height*Width*Depth(mm)	2000*800*1000	2000*1600*1000	2200*1600*1000	2200*2400*1000
	Standards and certifications	Standards: EN/IEC 62040-1, EN/IEC 62040-2, EN/IEC 62040-3 Certifications: CE; CB; RoHS, REACH, WEEE, etc.			
	Communications ports and protocol	Communications ports: Dry contacts, RS485, FE Communications protocol: Web, Modbus and SNMP			

Note: * The efficiency of the UPS system is the test result under typical working conditions, and it varies under different working conditions, and is subject to the actual use

The UPS5000 does not support energy feedback loads, such as elevators, medical CT machines, semiconductor cutting machines, and other motor loads that use energy feedback inverters.

SPECIFICATIONS 200V/208V/210V

Model		UPS5000-H-300k-NT
Capacity	Rack Capacity	300kVA
	Module number	2-6
Mains Input	Wiring	3Ph+N+PE
	Rated Voltage	200/208/210Vac
	Rated Frequency	50/60Hz
	Connection	Single or dual input
	Voltage Range	0-30°C: 138-260Vac (100% load: 170-260Vac) 30-40°C: 138-260Vac (100% load: 180-260Vac)
	Frequency Range	40-70Hz
	Total Harmonic Distortion	THDi<3% for 100% linear load
	Power Factor	0.99
Bypass Input	Wiring	3Ph+N+PE
	Rated Voltage	200/208/210Vac
	Rated Frequency	50/60Hz
	Frequency range	±6Hz (Programmable, 0.5-6Hz, default±2Hz)
	Synchronized slew rate (Hz/sec)	0.1Hz/s~2Hz/s, default 0.6Hz/s
Battery	Battery Category	SmartLi(No communication), VRLA
	Rated Voltage	VRLA: 180-600Vdc (The number of VRLA can be selected from 15 to 50; 20 batteries rated, no battery neutral, support odd battery number); SmartLi: 512Vdc
	Battery parallel string	1-12
	Maximum charge capacity and current	Single power module: 15%, 30A
	Temperature compensation	0~6mV/°C
	Battery sharing	Support
Output	Wiring	3Ph+N+PE
	Rated Voltage	200/208/210Vac
	Voltage Regulation	±1%
	Frequency	Tracking the bypass input (Normal mode); 50/60Hz±0.05% (Battery mode)
	THDv	THDv<2% for linear load, THDv<5% for non linear load
	Overload Capacity	Inverter: 100% < load≤110% for 60 minutes, then transfer to bypass mode; 110% < load≤125% for 10 minutes, then transfer to bypass mode; 125% < load≤150% for 1 minute, then transfer to bypass mode
	Imbalance ratio	Voltage imbalance: 3%; Phase imbalance: ±1° (100% imbalance load)
	Inverter short circuit	200%
	Dynamic response	±5% (20ms recovery duration)
	Power Factor	1
Power Factor range	0.5 leading to 0.5 lagging without derating	

Note: * The efficiency of the UPS system is the test result under typical working conditions, and it varies under different working conditions, and is subject to the actual use

The UPS5000 does not support energy feedback loads, such as elevators, medical CT machines, semiconductor cutting machines, and other motor loads that use energy feedback inverters.

SPECIFICATIONS 200V/208V/210V

Model		UPS5000-H-300k-NT
Capacity	Rack Capacity	300kVA
	Module number	2-6
System	Topology	Three level of IGBT double conversion
	Icw (kA)	35
	Heat dissipation(kW)	26
	Heat dissipation(kW)	62324
	Color	RAL9005
	Efficiency	Up to 94.5% *
	Heat Dissipation Mode	Built-in fan for heat dissipation. Front-to-back exhaust by default.
	Cable entry	Top in top output
	Lightning protection(kA)	5(optional)
	Source share mode	Support main input and battery source sharing
	Dust proof	Dustproof cotton in the front door
	Battery cold start	Support
	Remote EPO	Support
	Parallel	2
Display	LCD screen	7 inch touchable screen
	Indicator	Status indicators on the power module, bypass module, and monitoring module.
	Display	Load rate, battery capacity percentage, and remaining backup time
Optional accessory	BCB box	PDU8000 battery circuit break
	Cable connection	/
	Bottom cable entry	Support bottom cable entry
	Top air exhausting	/
	Lightning protection box	Optional 5kA
	Back feed protection card	Support main and bypass back feed protection
	Dry contact expansion card	5 DI and 5 DO ports
	Couple inductor cabinet	/
	Isolation switch	/
Environment	Operating Temperature	0-55°C,0-40°C no derating, 40-55°C with derating
	Storage Temperature	-40-70°C
	Protection level	IP20
	Relative Humidity	0%-95% (No condensing)
	Operating Altitude	0-2000m. Above 2000m, derating based on EN/IEC 62040-3
Others	Weigh	800kg
	Height*Width*Depth(mm)	2000*800*1000
	Standards and certifications	Standards: EN/IEC 62040-1, EN/IEC 62040-2, EN/IEC 62040-3 Certifications: CE; CB; RoHS, REACH, WEEE, etc.
	Communications ports and protocol	Communications ports: Dry contacts, RS485, FE Communications protocol: Web, Modbus and SNMP

Note: * The efficiency of the UPS system is the test result under typical working conditions, and it varies under different working conditions, and is subject to the actual use

The UPS5000 does not support energy feedback loads, such as elevators, medical CT machines, semiconductor cutting machines, and other motor loads that use energy feedback inverters.

SPECIFICATIONS 480V

Model		UPS5000-H-800k-NT
Capacity	Rack Capacity	800kVA
	Module number	2-8
Mains Input	Wiring	3Ph+N+PE
	Rated Voltage	480Vac
	Rated Frequency	50/60Hz
	Connection	Single or dual input
	Voltage Range	192-528Vac (100% load: 384-528Vac)
	Frequency Range	40-70Hz
	Total Harmonic Distortion	THDi<3% for 100% linear load
	Power Factor	0.99
Bypass Input	Wiring	3Ph+N+PE
	Rated Voltage	480Vac
	Rated Frequency	50/60Hz
	Frequency range	±6Hz (Programmable, 0.5-6Hz, default±2Hz)
	Synchronized slew rate (Hz/sec)	0.1Hz/s~2Hz/s, default 0.6Hz/s
Battery	Battery Category	SmartLi(No communication), VRLA
	Rated Voltage	VRLA: 360-600Vdc (The number of VRLA can be selected from 30 to 50; 40 batteries rated, no battery neutral, support odd battery number); SmartLi: 512Vdc
	Battery parallel string	1-12
	Maximum charge capacity and current	Single power module: 15%, 30A
	Temperature compensation	0~6mV/°C
	Battery sharing	Support
Output	Wiring	3Ph+N+PE
	Rated Voltage	480Vac
	Voltage Regulation	±1%
	Frequency	Tracking the bypass input (Normal mode); 50/60Hz±0.05% (Battery mode)
	THDv	THDv<2% for linear load, THDv<5% for non linear load
	Overload Capacity	Inverter: 100% < load≤110% for 60 minutes, then transfer to bypass mode; 110% < load≤125% for 10 minutes, then transfer to bypass mode; 125% < load≤150% for 1 minute, then transfer to bypass mode
	Imbalance ratio	Voltage imbalance: 3%; Phase imbalance: ±1° (100% imbalance load)
	Inverter short circuit	200%
	Dynamic response	±5% (20ms recovery duration)
	Power Factor	1
Power Factor range	0.5 leading to 0.5 lagging without derating	

Note: * The efficiency of the UPS system is the test result under typical working conditions, and it varies under different working conditions, and is subject to the actual use

The UPS5000 does not support energy feedback loads, such as elevators, medical CT machines, semiconductor cutting machines, and other motor loads that use energy feedback inverters.

SPECIFICATIONS 480V

Model		UPS5000-H-800k-NT
Capacity	Rack Capacity	800kVA
	Module number	2-8
System	Topology	Three level of IGBT double conversion
	I _{cw} (kA)	35
	Heat dissipation(kW)	43.4
	Heat dissipation(kW)	147955
	Color	RAL9005
	Efficiency	Up to 97% *
	Heat Dissipation Mode	Built-in fan for heat dissipation. Front-to-back exhaust by default.
	Cable entry	Top in top output
	Source share mode	Support main input and battery source sharing
	Dust proof	Dustproof cotton in the front door
	Battery cold start	Support
	Remote EPO	Support
Parallel	1	
Display	LCD screen	7 inch touchable screen
	Indicator	Status indicators on the power module, bypass module, and monitoring module.
	Display	Load rate, battery capacity percentage, and remaining backup time
Optional accessory	BCB box	PDU8000 battery circuit break
	Cable connection	/
	Bottom cable entry	Support bottom cable entry
	Top air exhausting	/
	Lightning protection box	Optional 5kA
	Back feed protection card	Support main and bypass back feed protection
	Dry contact expansion card	5 DI and 5 DO ports
	Couple inductor cabinet	/
	Isolation switch	/
Environment	Operating Temperature	0-55°C,0-40°C no derating, 40-55°C with derating
	Storage Temperature	-40-70°C
	Protection level	IP20
	Relative Humidity	0%-95% (No condensing)
	Operating Altitude	0-2000m. Above 2000m, derating based on EN/IEC 62040-3
Others	Weight	1300kg
	Height*Width*Depth(mm)	2000*1600*1000
	Standards and certifications	Standards: EN/IEC 62040-1, EN/IEC 62040-2, EN/IEC 62040-3 Certifications: CE; CB; RoHS, REACH, WEEE, etc.
	Communications ports and protocol	Communications ports: Dry contacts, RS485, FE Communications protocol: Web, Modbus and SNMP

Note: * The efficiency of the UPS system is the test result under typical working conditions, and it varies under different working conditions, and is subject to the actual use

The UPS5000 does not support energy feedback loads, such as elevators, medical CT machines, semiconductor cutting machines, and other motor loads that use energy feedback inverters.



Huawei Digital Power

Copyright © Huawei Digital Power Technologies Co., Ltd. 2024. All rights reserved.

No part of this document may be reproduced or transmitted in any form or by any means without prior written consent of Huawei Technologies Co., Ltd.

General Disclaimer

The information in this document may contain predictive statements including, without limitation, statements regarding the future financial and operating results, future product portfolio, new technology, etc. There are a number of factors that could cause actual results and developments to differ materially from those expressed or implied in the predictive statements. Therefore, such information is provided for reference purpose only and constitutes neither an offer nor an acceptance. Huawei may change the information at any time without notice.

Huawei Digital Power Technologies Co., Ltd.

Huawei Industrial Base Bantian Longgang

Shenzhen 518129, P. R. China

Tel: +86-755-28780808

www.huawei.com