

UPS S-ECO Technology

White Paper

Reliable, Energy-Saving, and Innovative UPS Technology

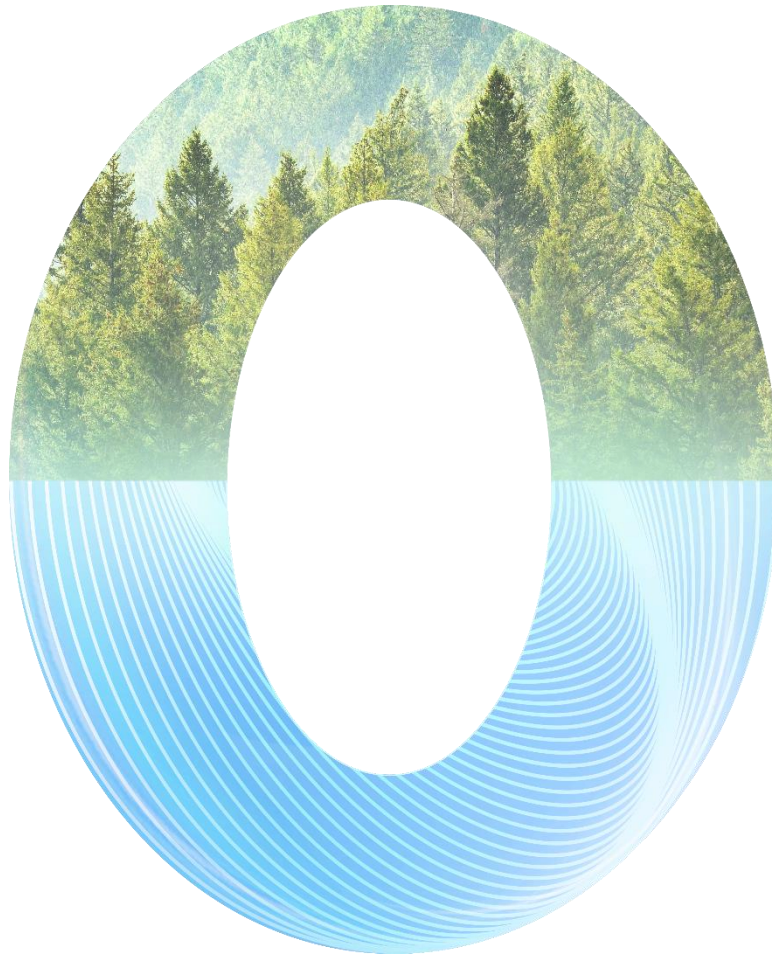

Thanks to the following organizations and individuals for drafting the white paper.

Chief editing organizations

Huawei Digital Power Technologies Co., Ltd., China Mobile Communications Group Co., Ltd., and Cloud Computing & Big Data Research Center of China Academy of Information and Communications Technology

Editors-in-chief

An Zhen, Cao Guoshui, Fei Zhenfu, Guo Liang, Li Baoyu, Li Huiyong, Li Junlin, Liang Haifeng, Liang Xianguang, Wan Xin, Wang Jianjun, Wang Junfei, Yang Bifei, Zhang Chuntao, Zhang Fan, Zhang Guanghe, and Zhang Zhanfan

Co-editing organizations

Beijing Telecom Planning & Designing Institute Co., Ltd., Beijing Meganest Technology Co., Ltd., Beijing HOYINN Technology Co., Ltd., Guangdong Planning and Designing Institute of Telecommunications Co., Ltd., Henghua Digital Technology Group Co., Ltd., Huaxin Consulting Co., Ltd., Chatone Smart Technology Co., Ltd., Dr. Peng Big Data Co., Ltd., Shandong Guowei Cloud Computing Co., Ltd., Shandong Kepu Power Supply System Co., Ltd., Shanghai Architectural Design Research Institute Co., Ltd., Shanghai Blue Buddy Intelligent Engineering Co., Ltd., Shanghai Posts & Telecommunications Designing Consulting Institute Co., Ltd., Tongji Architectural Design (Group) Co., Ltd., Xiangjiang Technology Co., Ltd., The IT Electronics Eleventh Design & Research Institute Scientific and Technological Engineering Corporation Limited, The Fourth Construction Co., Ltd. of China Electronics System Engineering, China Aviation Planning and Design Research Institute (Group) Co., Ltd., China Institute of Building Standard Design & Research Co., Ltd., Guangdong Electric Power Design Institute Co. Ltd. of China Energy Construction Group, China Mobile Group Design Institute Co., Ltd., China IPPR International Engineering Co., Ltd., CNISPGROUP Technology Co.,Ltd., China Information Consulting & Designing Institute Co., Ltd., and China Information Technology Design & Consulting Institute Co., Ltd.

Co-editors

Bao Shunqiang, Chen Xinghua, Du Lina, Gao Xiang, Gao Xiaoming, Hu Jie, Li Ya, Li Yusheng, Lian Jie, Liu Bo, Liu Jianxin, Liu Yewen, Pu Tingmin, Shen Wei, Wang Jianxin, Wu Jinsong, Liu Jingwei, Xu Ke, Teng Da Yang Wei, Ye Xiangyang, Zhang Lijuan, Zhang Wenli, Zhang Xuede, Zhong Xin

Contents

1. Foreword	04
2. Glossary	05
3. Development Trends	06
3.1. Regulatory Requirements for Low PUE	06
3.2. Status Quo of the Data Center Power Supply Industry	08
3.3. Overview, Advantages, and Disadvantages of Mainstream UPS Modes	10
3.3.1. Online Double-Conversion Mode	10
3.3.2. ECO Mode	11
4. Benefits and Technical Principles of the S-ECO Mode	12
4.1. Benefits and Recommended Architectures	12
4.1.1. Working Conditions: Various Power Grids Are Supported	15
4.1.2. Power Supply Architecture: Mainstream Data Center Architectures Support the S-ECO Mode	15
4.2. Technical Principles	16
4.2.1. High and Low Voltage Clamping Technology Ensures 0 ms Transfer Time Between Any Modes and High-Voltage Surge Suppression	16
4.2.2. Zero-Current Hot Backup Technology Ensures High Efficiency in the Full Load Range	17
4.2.3. Active Harmonic Compensation Technology Ensures an Equivalent Input PF as Double Conversion Mode	19

5. Verified Operation Reliability of Huawei S-ECO Mode	20
6. FAQs	26
7. Summary	27
Appendix 1	28
1-1 Settings and Running Status Verification	28
1-2 Input Adaptability Verification	32
1-3 Output Adaptability Verification	36

1. Foreword

As carbon neutrality has become a global consensus, countries around the world have issued conservation saving policies and put forward new requirements on industry development. In response to energy green transformation, China has proposed the "3060" carbon policy, aiming to hit peak carbon emissions before 2030 and carbon neutrality by 2060. The policy is being implemented across industries.

As big energy consumers, data centers face great challenges in energy conservation and consumption reduction and should speed up the pace of green development. The power supply system in a data center accounts for 10% of the total electricity cost of the entire data center facility. The uninterruptible power system (UPS) plays a critical role in the power supply system and consumes most power in the system. A typical method to reduce the UPS power consumption is to improve its efficiency in online mode or keep it running in ECO mode. The industry's highest efficiency in online mode is about 97%. Further increasing the efficiency will raise the cost to a higher level. The efficiency in ECO mode can easily exceed 99% as the utility power is directly supplied when the UPS works in ECO mode. However, if the utility power becomes abnormal, the power supply will be interrupted for several milliseconds when the UPS is transferring to battery mode. This reduces the power supply reliability and that is why ECO mode is not widely used.

The UPS industry calls for a working mode that ensures reliable power supply while delivering ultrahigh efficiency. This white paper describes the UPS S-ECO technology and its application in Huawei UPS5000-H products. The document illustrates its major benefits, technical principles, application scenarios, and comprehensive verification process, helping readers understand the S-ECO mode and providing approaches for designing highly reliable and efficient data centers or mission-critical power supply solutions in various industries.



2. Glossary

APFC: active power factor compensator

DC: data center

ECO: economic control operation

MTBF: mean time between failures

MTTR: man time to repair

PUE: power usage effectiveness

S-ECO: super economic control operation

SiC: silicon carbide

SVG: static var generator

THDi: total harmonic distortion of current

THDv: total harmonic distortion of voltage

VFI: voltage frequency independent

VFD: voltage frequency dependent

VI: voltage independent

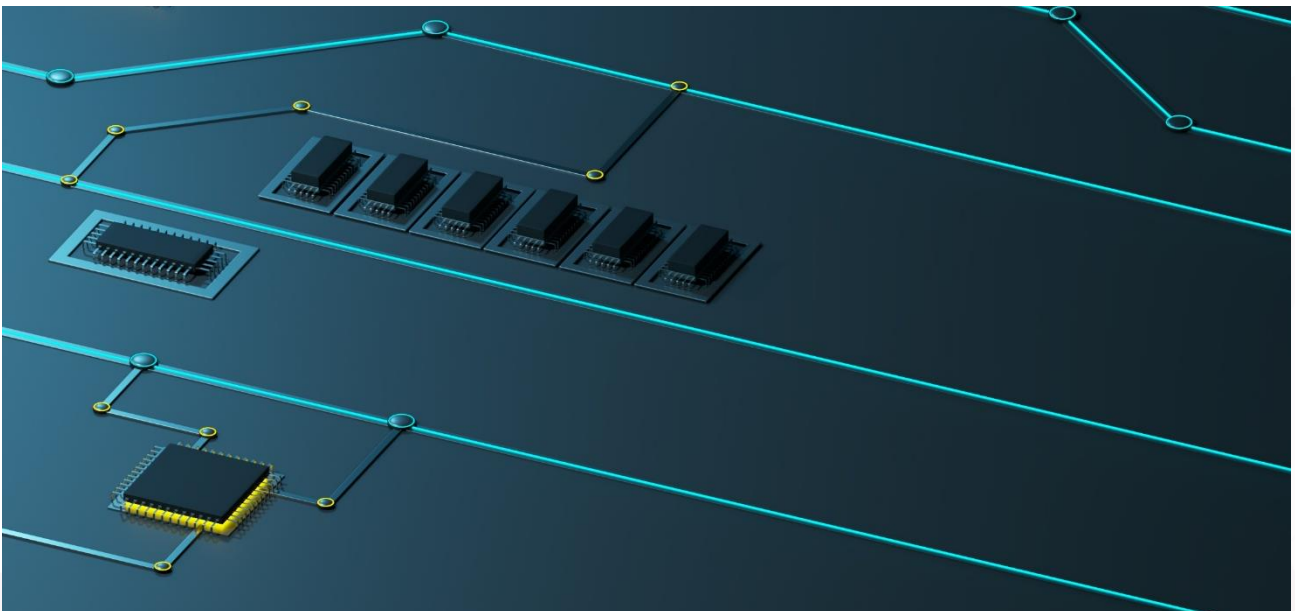

3. Development Trends

3.1. Regulatory Requirements for Low PUE

Carbon emissions from human activities accelerate global warming and have become a worldwide threat. Coping with climate change is a global responsibility. The Paris Agreement, which came into effect in 2016, has set targets for global warming control and carbon neutrality. The goal is to limit global average temperature rise to well below 2°C, preferably to 1.5°C. A total of 137 countries have announced policies or made commitments on carbon neutrality, and multiple major economies have released their green data center policies. Building green data centers has become an inevitable trend.

Though facing a number of challenges, China is determined on the way of low-carbon development. In the general debate of the 75th session of the UN General Assembly in 2020, China proposed to peak CO₂ emissions by 2030 and achieve carbon neutrality by 2060. China has proposed a revolutionary strategy for energy development in the new era. It has also issued regulations and incentive policies to control the volume and intensity of power consumption.

The national low-carbon policies have been implemented across industries. A number of policies have been issued in the data center field to drive green development and control the PUE.

The *Guiding Opinions on Accelerating the Construction of a Collaborative Innovation System for National Integrated Big Data Centers* was issued in December 2020. According to the document, a structural balance should be kept between data centers in eastern and western regions of China. The PUE of large and ultra-large data centers should be kept below 1.3. The PUE requirements vary with the eight regions. Average PUEs are set for each region and cluster.

Table 1 Energy efficiency limits and energy efficiency grades for data centers in eight regions

	Beijing, Tianjin, and Hebei	The Yangtze River Delta	Guangdong, Hong Kong, and Macao	Chengdu and Chongqing	Gansu	Guizhou	Ningxia	Inner Mongolia
Average PUE in a region	1.3	1.3	1.3	1.3	1.2	1.3	1.2	1.3
Average PUE in a cluster	1.25	1.25	1.25	1.25	1.2	1.2	1.2	1.2



The data center industry standards put forward specific requirements on the PUE. For example, the GB 40879-2021 *Maximum allowable values of energy efficiency and energy efficiency grades for data centers* specifies the energy efficiency grades, technical requirements, statistical ranges, and testing and calculation methods for data centers.

This standard sets three grades of data center energy efficiency. Grade 1 indicates the highest energy efficiency. The following table lists the requirements.

Table 2 GB 40879-2021 Maximum allowable values of energy efficiency and energy efficiency grades for data centers

Indicator	Energy Efficiency Grade		
	Grade 1	Grade 2	Grade 3
Data center PUE	1.20	1.30	1.50



3.2. Status Quo of the Data Center Power Supply Industry

The core power supply system of a data center typically consists of the utility power introduction, high/medium-voltage power distribution, low-voltage power distribution, UPS, backup power system, rack power distribution, genset, and management system.

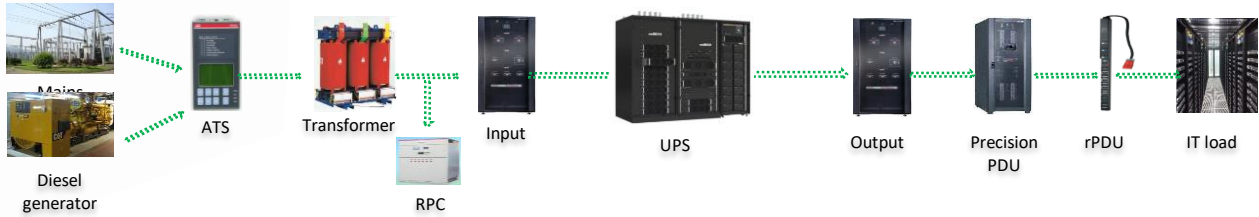

Figure 1 Power supply system of a data center

This document focuses on the AC UPS. Improving the efficiency of the power supply system can effectively reduce the PUE. Take a 10 MVA data center as an example. A 1% increase of the UPS efficiency will reduce the PUE by about 0.01. The following table lists the UPS efficiency data of major national/industry standards and flagship models in the industry. The UPS efficiency is not fixed, but varies with the load rate. The table also lists the efficiency requirements stipulated in the UPS industry standards.

Table 3 Efficiency requirements in UPS standards

	Load Rate	System Efficiency	Efficiency of Flagship Models
YD/T 1095-2018 AC uninterruptible power systems for telecommunications	100% resistive load	≥ 95%	≥ 96%
	50% resistive load	≥ 93%	≥ 97%
	30% resistive load	≥ 91%	≥ 97%
YD/T 2165-2017 Modular AC uninterruptible power systems for telecommunications	100% resistive load	≥ 94%	≥ 96%
	50% resistive load	≥ 94%	≥ 97%
	30% resistive load	≥ 90%	≥ 97%
GB/T 14715-2017 General specification for uninterruptible power supply for information technical equipment	100% resistive load	Grade 1: ≤ 93.7% Grade 2: ≤ 93% Grade 3: ≤ 91.3%	≥ 96%
	75% resistive load	Grade 1: ≤ 93.7% Grade 2: ≤ 93% Grade 3: ≤ 91.3%	≥ 96%
	25% resistive load	Grade 1: ≤ 92.8% Grade 2: ≤ 92% Grade 3: ≤ 90.1%	≥ 96%
	15% resistive load	Grade 1: ≤ 90.1% Grade 2: ≤ 89% Grade 3: ≤ 86.4%	≥ 95%

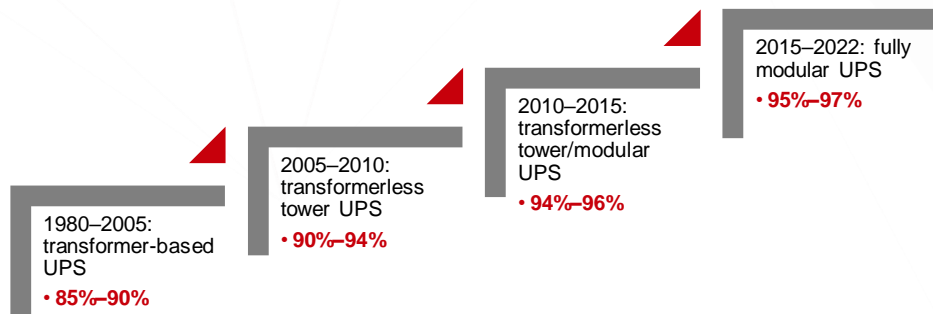
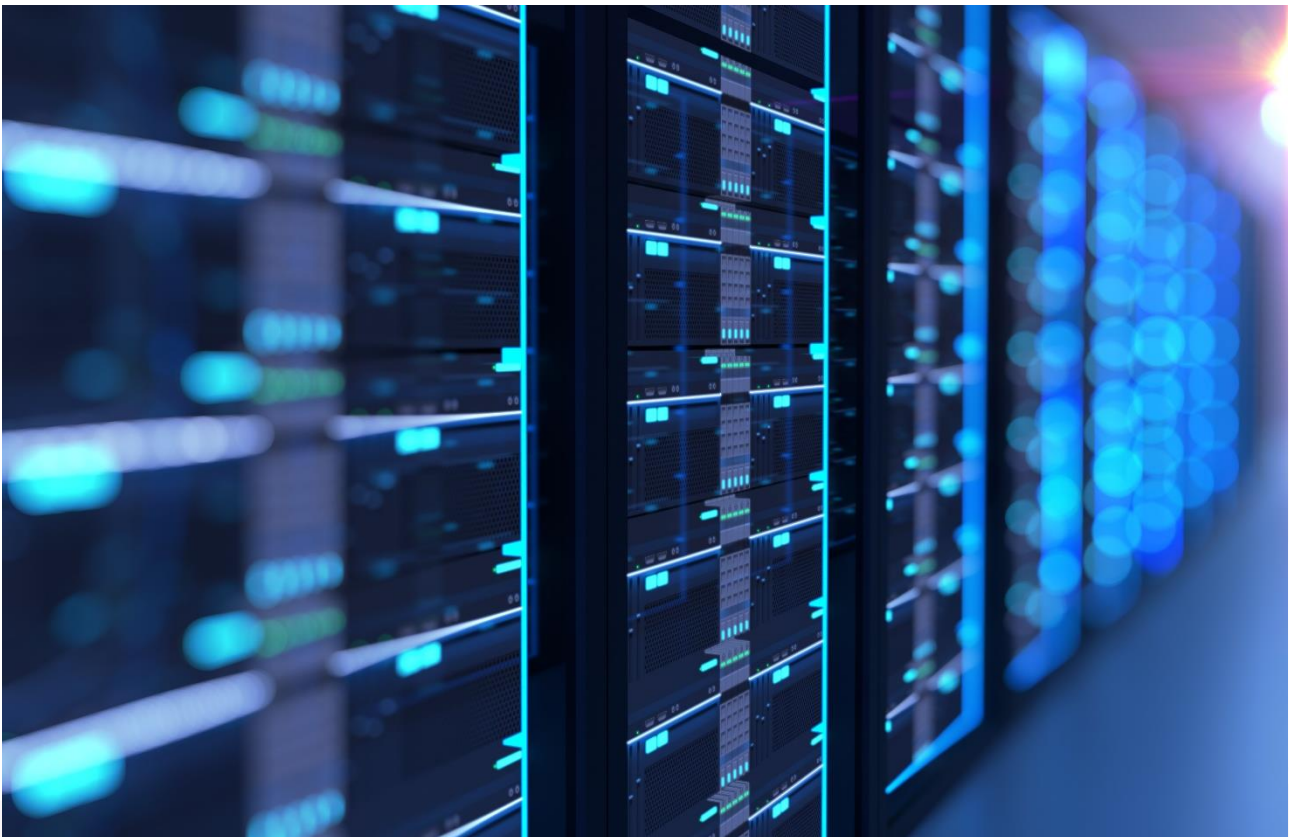

Figure 2 UPS efficiency improvement

Figure 2 shows the UPS efficiency improvement over decades. The UPS efficiency has been improving rapidly for the past decade. However, due to the restrictions of topology, components, and techniques, it becomes increasingly hard to break the 97% efficiency bottleneck in online mode. The reasons are as listed:

- ① **Topology:** The three-level IGBT double-conversion architecture has been used for many years. Considering product reliability and component adaptability, this topology will still be used in a short term.
- ② **Components:** SIC components have been widely used in flagship products across the industry, and the component power consumption is at all time low. It is challenging to further improve the efficiency in online mode by upgrading components.
- ③ **Line loss:** Restricted by Ohm's Law, the internal line loss of a high-power UPS cannot be reduced.

For the preceding reasons, innovation is called for to break the UPS efficiency bottleneck and improve energy saving benefits.



3.3. Overview, Advantages, and Disadvantages of Mainstream UPS Modes

All UPSs used in data centers are online double-conversion products. Their core units include the rectifier, inverter, charger/discharger, and static bypass. The UPSs are classified into two categories: online double-conversion mode and ECO mode.

3.3.1. Online Double-Conversion Mode

Online double-conversion is the most commonly used mode of UPSs. Based on the status of different input sources, the UPS can work in normal, bypass, or battery mode.

Normal Mode

The rectifier converts AC power into DC power, and then the inverter converts DC power into AC power. Batteries are charged by a charger. After two-level conversion, the output voltage with high precision and quality is generated. This prevents input harmonics, glitches, and voltage transients from affecting loads.

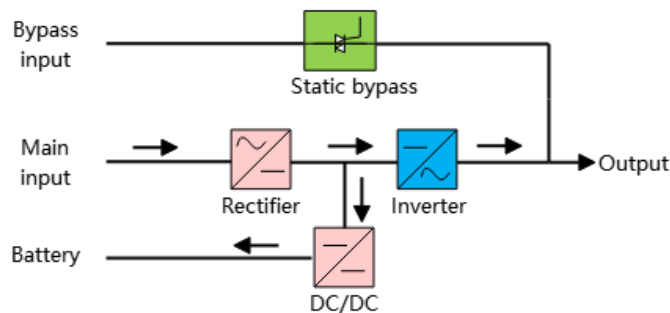

Figure 3 Online double-conversion mode (normal mode)

Bypass Mode

When the UPS detects power module over temperature, overload, or other faults that may shut down the inverter, the UPS automatically transfers to bypass mode. At the same time, the rectifier is started and charges batteries over a charger. In bypass mode, loads are powered by the bypass module. The bypass power supply is not protected by the UPS and therefore is prone to the power outage, abnormal AC voltage, or abnormal frequency.

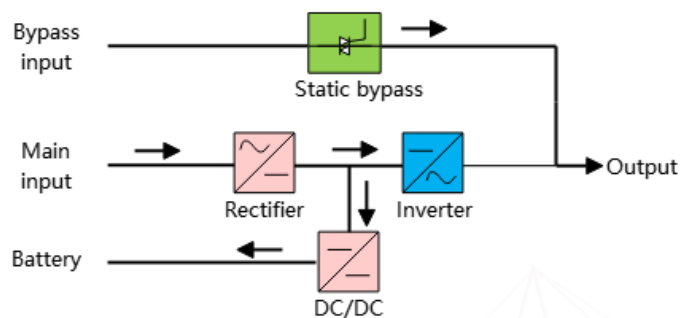

Figure 4 Online double-conversion mode (bypass mode)

Battery Mode

If the utility power input is abnormal or the rectifier becomes abnormal, the UPS transfers to battery mode. The power module obtains energy from batteries, and the energy is converted into AC output voltage by the inverter.

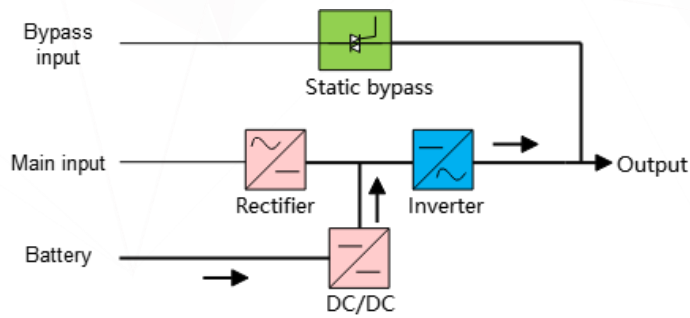

Figure 5 Online double-conversion mode (battery mode)

3.3.2. ECO Mode

The ECO mode can be used when the online double-conversion mode cannot meet the requirement for higher UPS efficiency. In ECO mode, when the bypass input is within the ECO voltage and frequency ranges and other ECO power supply conditions are met, the power is supplied through the bypass and the inverter is standby. When the bypass source voltage is outside the ECO voltage range, the UPS transfers from bypass mode to inverter mode. Either in bypass mode or inverter mode, the rectifier is started all the time and charges batteries using a charger. The ECO mode guarantees high efficiency.

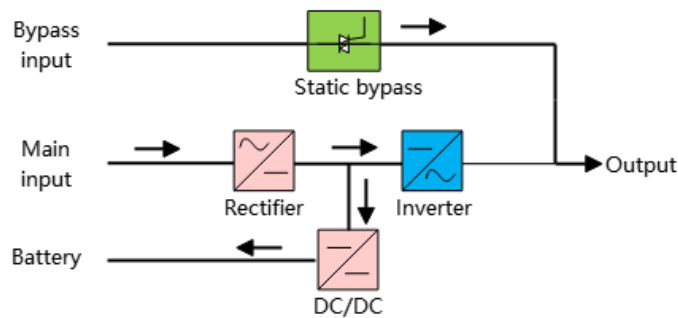

Figure 6 ECO mode

In ECO mode, it takes up to 10 ms for the UPS to transfer from bypass mode to inverter mode, which causes load power failure. In addition, the UPS cannot compensate for load harmonics. Although this mode delivers efficiency up to 99%, it is seldom used in data centers.

The following table lists the mapping between the mainstream UPS working modes.

Table 4 Features of UPS working modes

IEC62040 Standard Definition	UPS Mode	Efficiency	Features	IEC 62040 Dynamic Response to Switching	Power Grid Requirements	Application Scenarios
VFI	Online mode	Up to 97%	Reliable power supply, 0 ms transfer time between any modes	Class 1	Moderate or poor power grid quality	More than 95% scenarios and almost all data center scenarios
VFD	ECO mode (quasi-resistive load)	Up to 99%	Up to 10 ms interruption in switching to battery mode, load harmonics feedback to the power grid	Class 3	Good power grid quality, low load harmonics	Scenarios with < 10 ms interruption acceptable
VI	ECO mode (non-resistive load)	Up to 98.5%	Up to 10 ms interruption in switching to battery mode, load harmonics passing the inverter filter	Class 3	Good power grid quality, high load harmonics	Scenarios with < 10 ms interruption acceptable

Each mode has its disadvantages. The online mode has low efficiency, and the ECO mode has high efficiency but an interruption during switching. If the advantages of the two modes are combined, the UPS works in ECO mode by default to solve the problems of interruption and harmonic compensation. The S-ECO mode is such an innovation. The following describes the benefits and technical principles of the S-ECO mode.

4. Benefits and Technical Principles of the S-ECO Mode

4.1. Benefits and Recommended Architectures

S-ECO is an innovative UPS working mode based on the S-ECO technology. It optimizes the power supply architecture and logic and solves the problems of low system efficiency in online double-conversion mode, output interruption, large harmonics, and input surge voltage interference in ECO mode. The S-ECO mode provides the following benefits: **0 ms transfer time between any modes, high efficiency in the full load range, high-voltage surge suppression, and active harmonic compensation.**

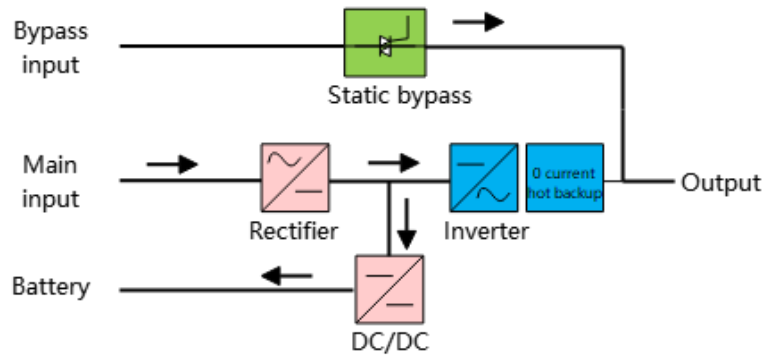

Figure 7 S-ECO mode

4.1.1. 0 ms Transfer Time Between Any Modes

When the UPS works in S-ECO mode, it automatically detects the power quality of the bypass input. When the bypass input is normal, the bypass supplies power. When the bypass input is abnormal, the UPS transfers to inverter mode with 0 ms. (If the mains input is normal, the UPS works in normal mode. If both the mains and bypass inputs are abnormal, the UPS works in battery mode.) The dynamic response level of class 1 defined in IEC 62040-3 is met. The UPS automatically transfers back to bypass mode once the bypass recovers.

4.1.2. High Efficiency in the Full Load Range

When the bypass supplies power, the UPS power consumption is extremely low, and the system efficiency is greater than 99.1% at its peak or 98.5% when the load rate is above 20%.

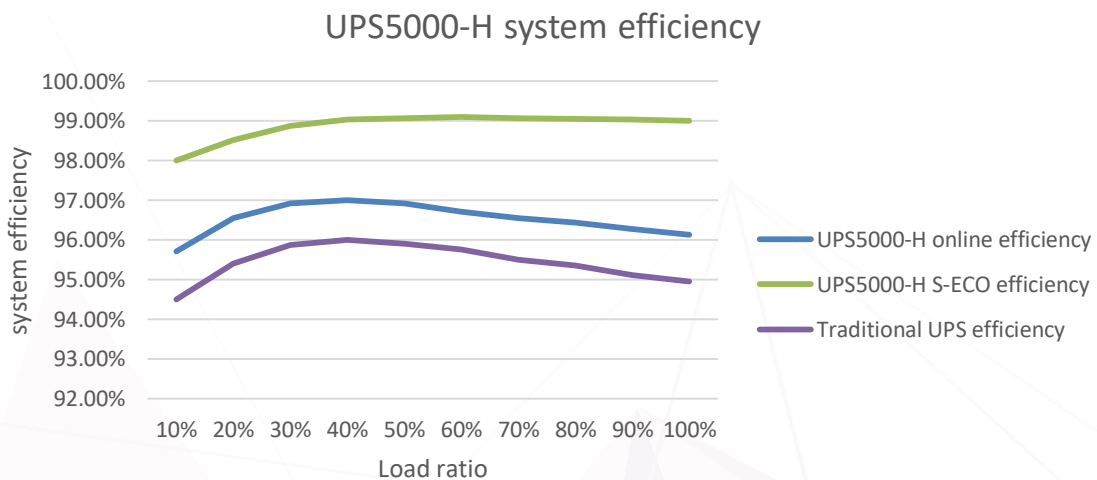

Figure 8 Efficiency curve in S-ECO mode

Data centers usually have a low load change rate. The following figure shows the load rates of a data center in different periods of a day. The change rate between peak and off-peak values is only 9.9%. In this case, the S-ECO mode also supports power module hibernation.

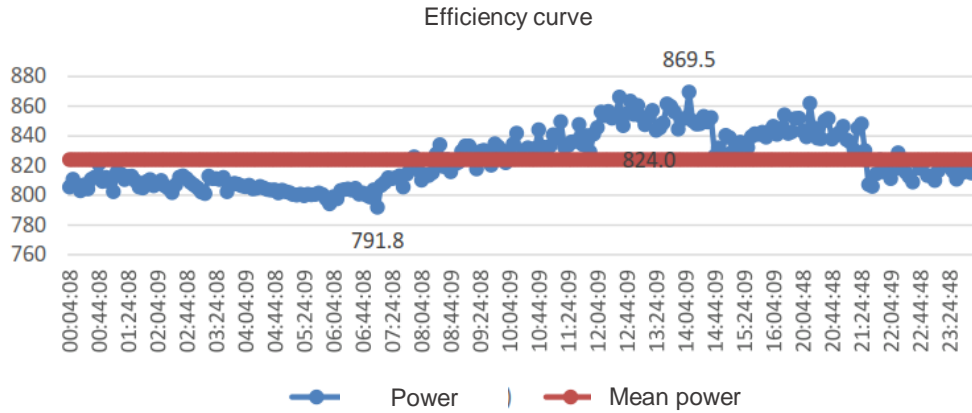

Figure 9 Load rate change curve of a data center in a day

This function automatically detects the load rate and allows a certain number of power modules to hibernate to reduce the power consumption. Only the inverters in the modules hibernate, and the rectifiers and charger keep running. If sudden load change, mode change, or other exceptions occur, the modules can quickly wake up from the hibernation state. The wakeup time is as short as 5 ms, ensuring reliable power supply.

According to the preceding figure, if a 1200 kVA UPS is configured, the load is 791 kW, the load rate is 66%, and four modules hibernate at 6:44:08; the load rate is 869 kW, the load rate is 72%, and three modules hibernate at 14:04:09. The data indicates that the number of hibernating modules can be automatically adjusted depending on the load rate.

4.1.3. High-Voltage Surge Suppression

When the bypass supplies power directly, the surge voltage of the bypass input is easily transmitted to load ports. To address the high surge voltage, the S-ECO mode uses the high and low voltage clamping technology to compensate voltage when it decreases and absorb voltage when it increases. It has been verified that the output voltage meets IEC 61000-4-5 requirements on surge voltage.

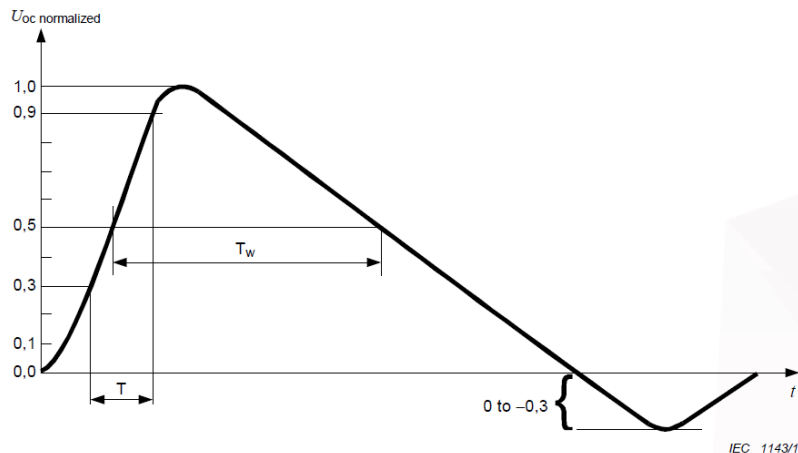

Front time: $T_f = 1,67 \times T = 1,2 \mu s \pm 30 \%$
 Duration: $T_d = T_w = 50 \mu s \pm 20 \%$

NOTE The value 1,67 is the reciprocal of the difference between the 0,9 and 0,3 thresholds.

Figure 10 Surge voltage test requirements in IEC 61000-4-5

4.1.4. Active Harmonic Compensation

The power supply units in IT equipment provide the power factor correction (PFC) function. When the input power factor (PF) is good (> 0.9), the bypass can supply power directly. However, mechanical and process equipment, such as air conditioners, fans, and water pumps, do not have the PFC function. When the bypass supplies power directly in the traditional ECO mode, reactive power and high-order harmonics are generated and flow into the power grid, which increases the line loss, accelerates the insulation aging, and shortens the equipment service life.

In S-ECO mode, the system automatically detects the actual harmonics. If the harmonics exceed the preset value, the inverter automatically starts to compensate for the harmonic component in the load, ensuring that the system input harmonics are small and the PF is high. Using 100% non-resistive load as an example, the input PF is only 0.7–0.8 in traditional ECO mode and becomes greater than 0.99 after compensation. The S-ECO mode saves the APF or SVG compensation device that is needed in traditional ECO mode.

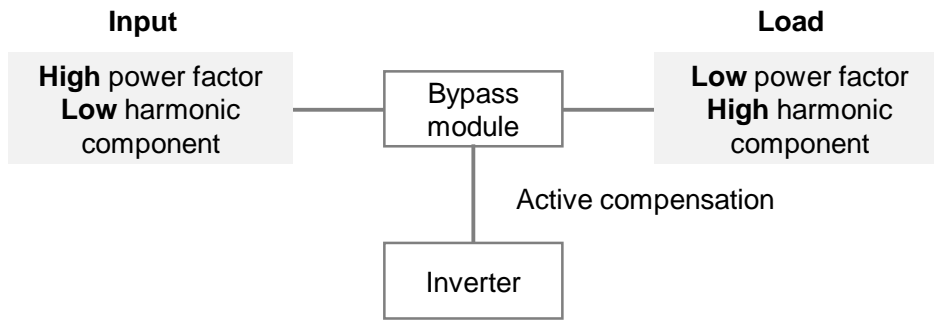

Figure 11 Active harmonic compensation



4.1.5. Working Conditions: Various Power Grids Are Supported

The UPS determines to work in online mode or S-ECO mode based on the power grid quality. The mode selection process is set during the design phase and initial power-on. Users do not need to set it after the UPS is put into use.

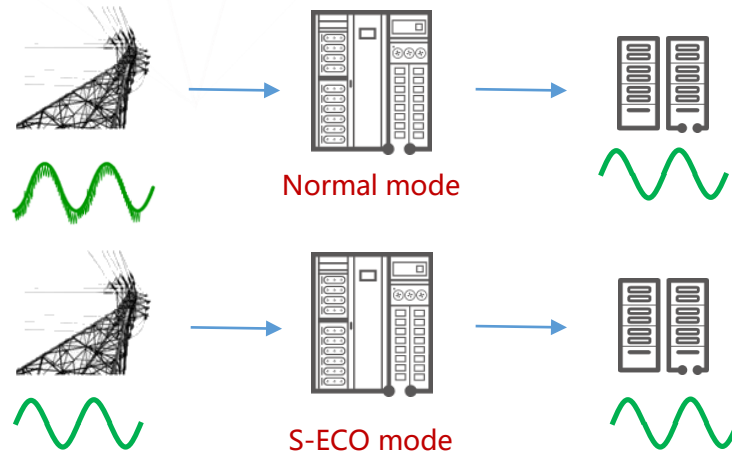

Figure 12 Recommended operating modes for different power grid quality

The S-ECO mode has no requirement on the frequency of power grid failure. It is recommended that the UPS run in an environment with a stable power grid. The reference voltage, frequency, and harmonics are as follows:

- Voltage range: 380 V±10%
- Frequency range: 50 Hz±2%
- THDv: < 8%

4.1.6. Power Supply Architecture: Mainstream Data Center Architectures Support the S-ECO Mode

Similar to online mode, the S-ECO mode applies to multiple power supply architectures. In the 2N architecture, dual-route S-ECO mode and one-route S-ECO mode plus one-route online double-conversion mode are applicable.

Table 5 Recommended power supply architectures

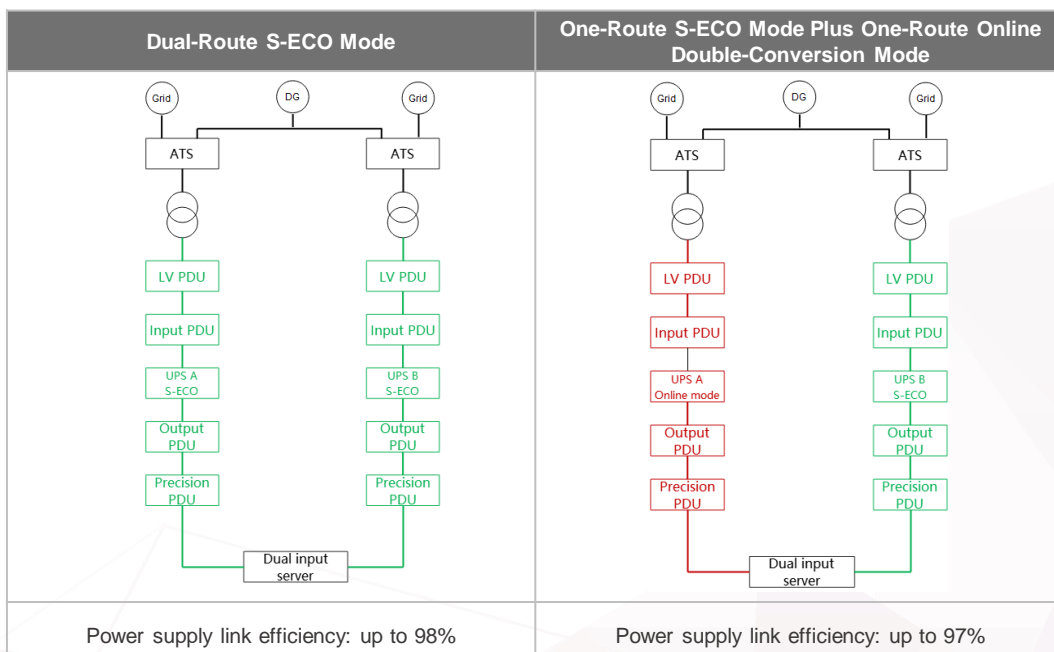

4.2. Technical Principles

The benefits of the S-ECO mode are achieved using proprietary technologies. This section describes its technical principles.

4.2.1. High and Low Voltage Clamping Technology Ensures 0 ms Transfer Time Between Any Modes and High-Voltage Surge Suppression

In traditional ECO mode, an interruption of up to 10 ms occurs when the system transfers from bypass mode to normal mode due to the following reasons, and IT and mechanical loads may encounter a power failure during the transfer.

- ① Bypass input detection delay (major cause)
- ② Control signal transmission delay
- ③ Bypass thyristor zero-crossing shutdown (half-controlled component)
- ④ Inverter start delay

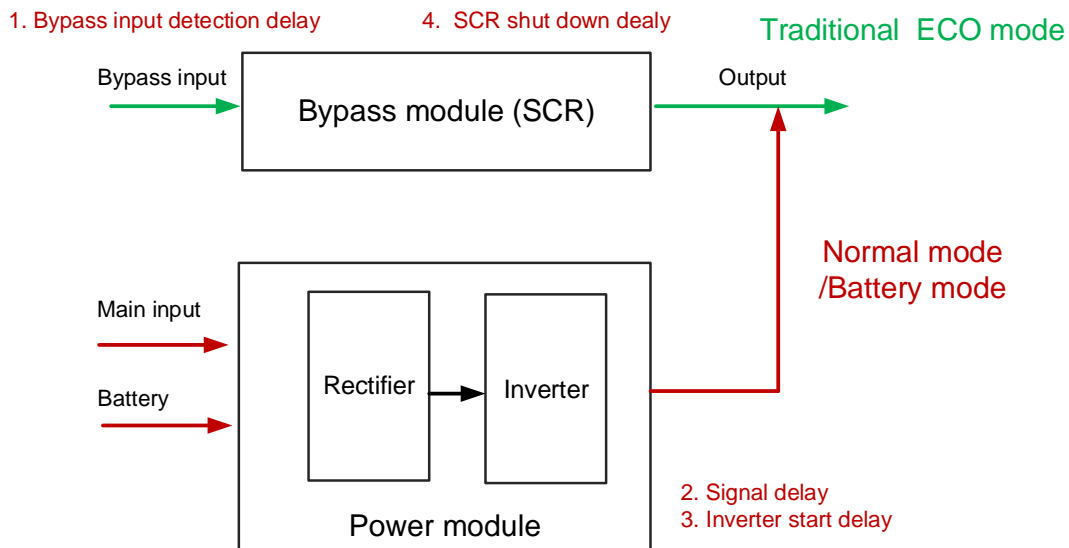

Figure 13 Causes of interruption in the traditional ECO mode

Huawei S-ECO mode uses the hardware-based high and low voltage clamping technology. When the bypass input experiences a transient voltage sag or high voltage surge, certain power modules supply 210 V voltage through inverters to implement low-voltage clamping, and other power modules supply 230 V voltage through inverters to implement high-voltage clamping thanks to the modular architecture. The clamping amplitude is ± 10 V. Hardware-based clamping ensures 0 ms transfer time without waiting for software detection or signal transmission delay, improving system reliability.

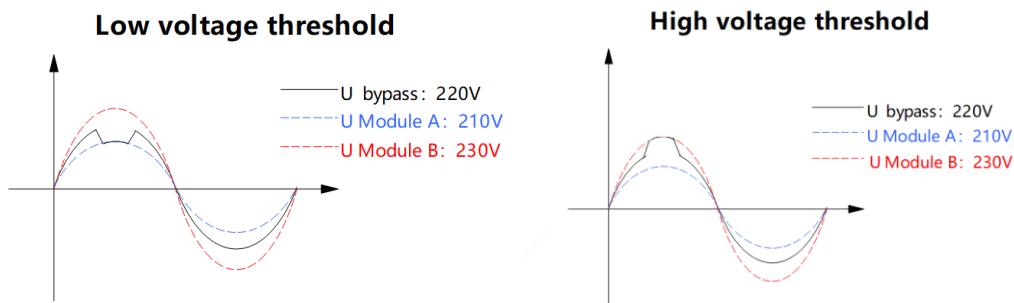

Figure 14 High and low voltage clamping using the S-ECO technology

The following table compares the low-current backup and zero-current hot backup technologies. The zero-current hot backup technology delivers higher efficiency.

Table 6 Comparison between zero-current and low-current hot backup technologies

	Dynamic Response	Backup Current	Efficiency	Mains and Bypass Relationship	Cost
Low-current backup	Class 1/Class 3	Low	Up to 98.5%	Directly connected in parallel	Low
Zero-current hot backup	Class 1	None	Up to 99.1%	Hardware isolation	Medium

In addition to the zero-current hot backup technology, the intelligent hibernation technology enables some power modules to hibernate to improve the efficiency within the full load range. The UPS automatically predicts that the load rate of the remaining working modules will be less than 100% based on the current load rate and allows the other modules to hibernate. The efficiency exceeds 98.5% when the load rate is greater than 20%. If the UPS predicts that the load rate of the remaining working modules will be greater than 100%, the UPS wakes up the hibernating modules within 5 ms to ensure reliable power supply.

The hibernation mode also supports a rotation mechanism. The hibernation interval is measured by day. The modules work and hibernate at the scheduled time to ensure that the working duration of the modules is consistent.

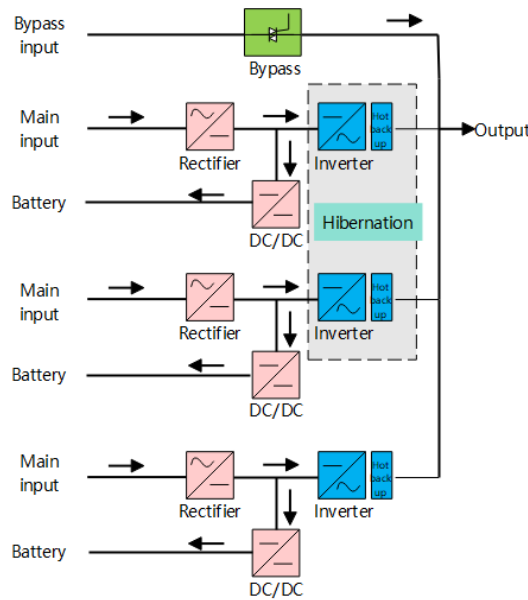
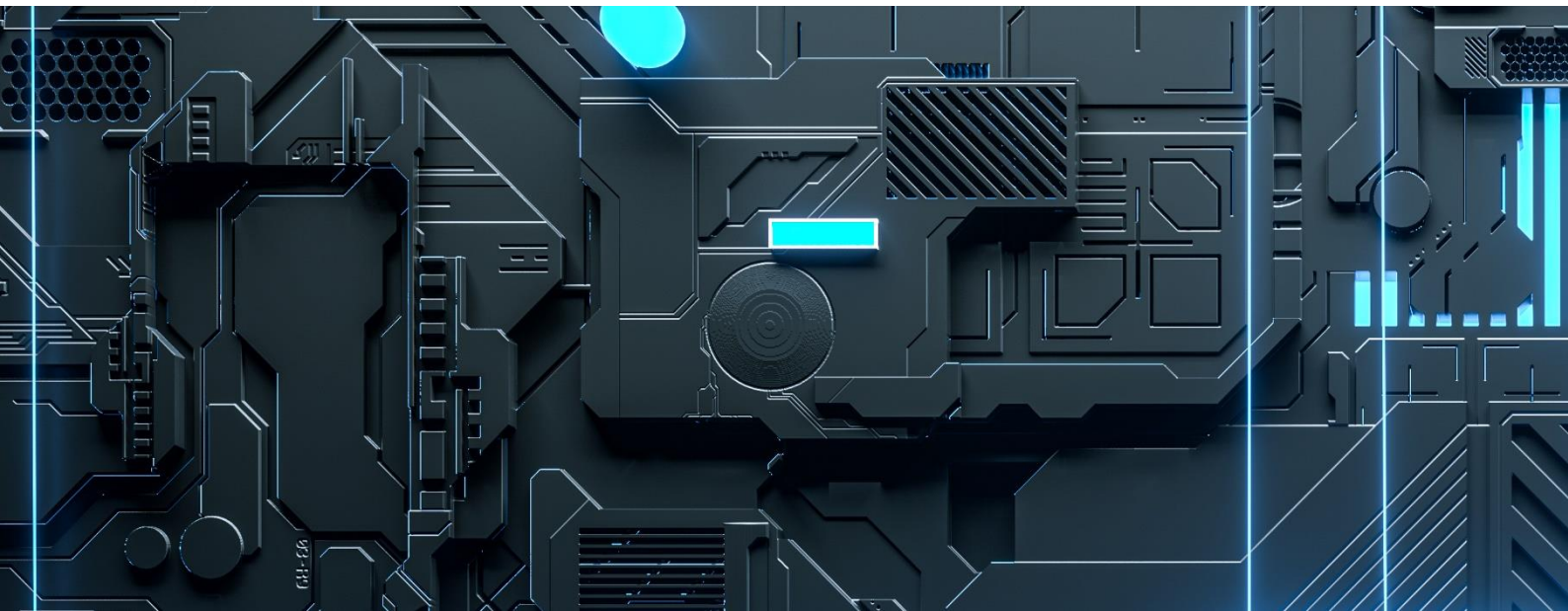

Figure 17 Hibernation using the S-ECO technology



4.2.3. Active Harmonic Compensation Technology Ensures an Equivalent Input PF as Double-Conversion Mode

The S-ECO mode provides active harmonic compensation for non-resistive loads. The key working principles are as follows:

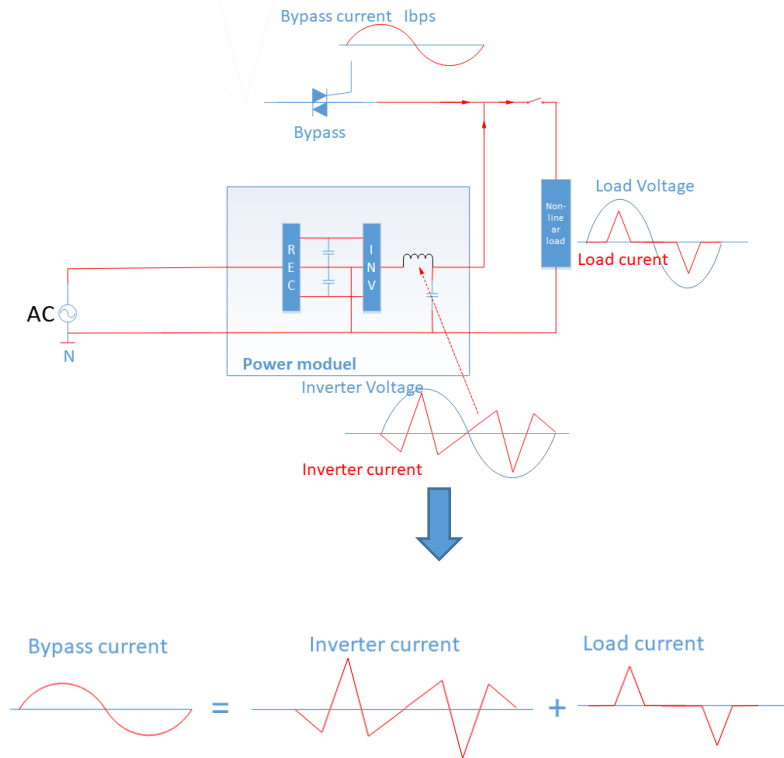

Figure 18 Active harmonic compensation using the S-ECO technology

The system analyzes the UPS output load current I_{load} , identifies the harmonic component, and sends it to the inverter for calculation. The inverter works in current source mode and outputs the harmonic compensation current I_{inv} based on the load harmonic current. All load harmonic currents are provided by the inverter, and the bypass input current I_{bps} is only a fundamental component, ensuring that the THDi of the power grid input current is minimal.

The S-ECO mode can adapt to various combinations of loads, including resistive, resistive-capacitive, resistive-inductive, and non-linear loads. The inverter can compensate for the reactive component of loads with the effect equivalent to that in online mode. The S-ECO mode ensures that the system input PF is greater than 0.99 and the input THDi is less than 5% at full load.

5. Verified Operation Reliability of Huawei S-ECO Mode

Huawei UPS5000-H flagship models are equipped with the S-ECO mode, and its performance has been fully verified. The models cover the capacity of 400 kVA to 1600 kVA and are applicable to medium- and large-capacity data centers and mission-critical power supplies in various industries.



UPS5000-H-(400/500/600 kVA)
2000 x 800 x 1000



UPS5000-H-800 kVA
2000 x 1600 x 1000



UPS5000-H-1200 kVA
2200 x 1600 x 1000



UPS5000-H-1600 kVA
2200 x 2400 x 1000

Dimensions (H x W x D, mm)

Figure 19 Huawei UPS5000-H series

The common load rate of a data center is 20%–80%. The UPS5000-H can achieve an efficiency of over 98.5% when it carries 20%–100% loads and deliver an efficiency up to 99.1% at the peak point. Compared with other energy-saving modes in the industry, the S-ECO mode is highly efficient within the full load range. According to the efficiency test result shown in the following figure, when the bypass input is abnormal, the UPS transfers to online dual-conversion mode and delivers the efficiency up to 97%, which can exceed 95.5% if the load is higher than 10%. The UPS5000-H is extremely energy-saving.

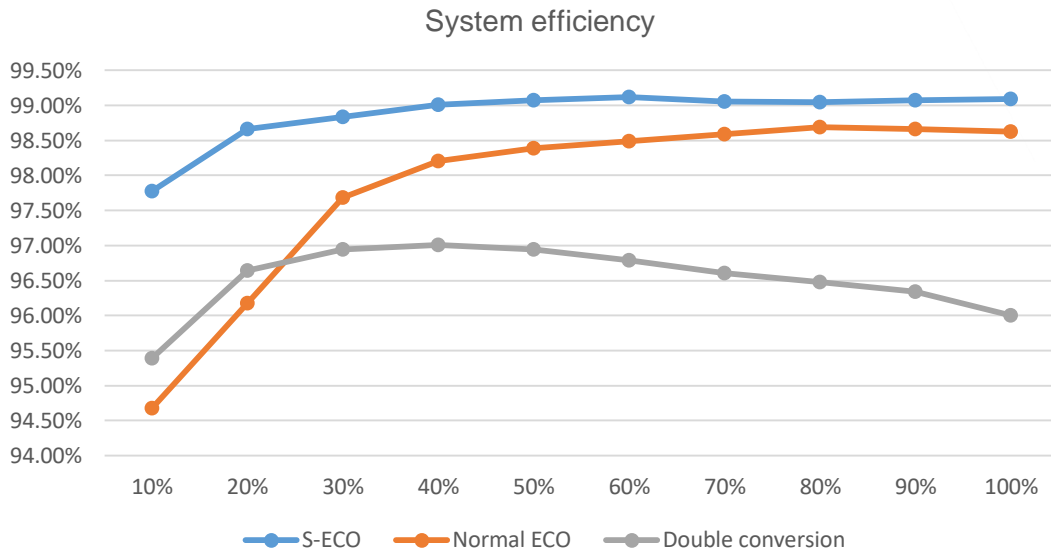

Figure 20 Efficiency curve in S-ECO mode

The S-ECO mode provides 2% higher half-load efficiency and 3% higher full-load efficiency than the online double-conversion mode. Take the half-load efficiency as an example. If the electricity fee is US\$0.12/kWh, the 10-year electricity cost of a 10 MW data center can be reduced by US\$1.16 million.

Table 7 Electricity cost reduction for models with different capacities

UPS Rated Capacity (kW)	Actual Load (40%)	Efficiency Improvement	10-Year Electricity Cost Reduction (US\$)	Electricity Fee (US\$/kWh)
400	160	2%	46,420	0.12
800	320	2%	92,840	0.12
1200	480	2%	139,400	0.12
1600	640	2%	185,800	0.12
2000	800	2%	232,200	0.12
2400	960	2%	278,800	0.12
3200	1280	2%	371,600	0.12
10000	4000	2%	1,161,800	0.12

To verify that the UPS output is not interrupted under any working conditions in S-ECO mode, the UPS5000-H was tested in accordance with the IEC 62040 and YD/T 2165 standards. All test results meet the requirements. For details, see Appendix 1.

■ **Input adaptability:**

- Input overvoltage and undervoltage
- Input overfrequency and underfrequency
- Input power failure
- Input surge
- Input voltage distortion

■ **Output adaptability**

- Active harmonic compensation
- Output dynamic response
- Output short circuit

In a common power failure test as shown in the following figure, the output carries resistive loads and the system works in VFD mode. If the bypass input voltage fails, the system transfers to normal mode with 0 ms and triggers a bypass voltage abnormality alarm. After the bypass voltage recovers, the alarm is cleared automatically. The UPS transfers back to bypass mode with 0 ms 5 minutes later.

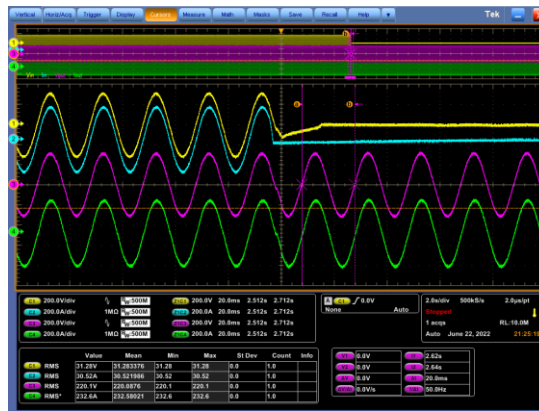

Figure 21 Yellow: bypass input voltage; blue: bypass input current; purple: system output voltage; green: system output current

The efficiency of active harmonic compensation is critical for the UPS to supply power to non-linear loads such as mechanical loads. In the test, the UPS works in S-ECO mode with harmonic compensation enabled and supplies power to loads whose PF is 0.7. According to the test result, the bypass input PF and THDi after harmonic compensation in S-ECO mode are equivalent to those in double conversion mode.

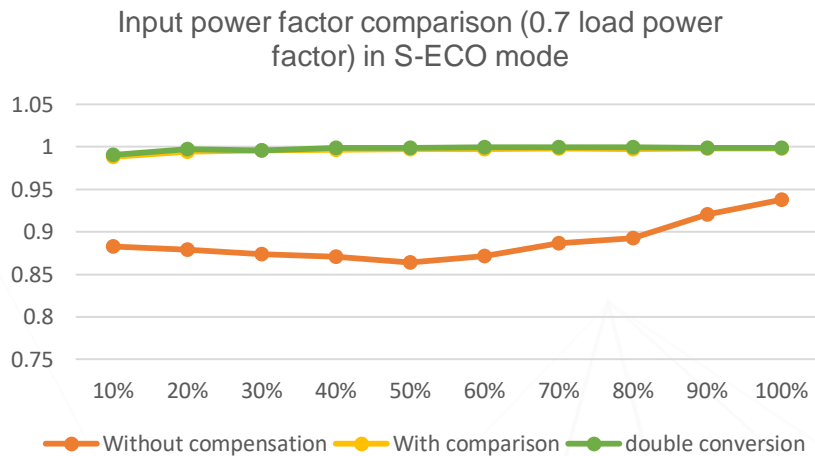

Figure 22 PF comparison for harmonic compensation in S-ECO mode

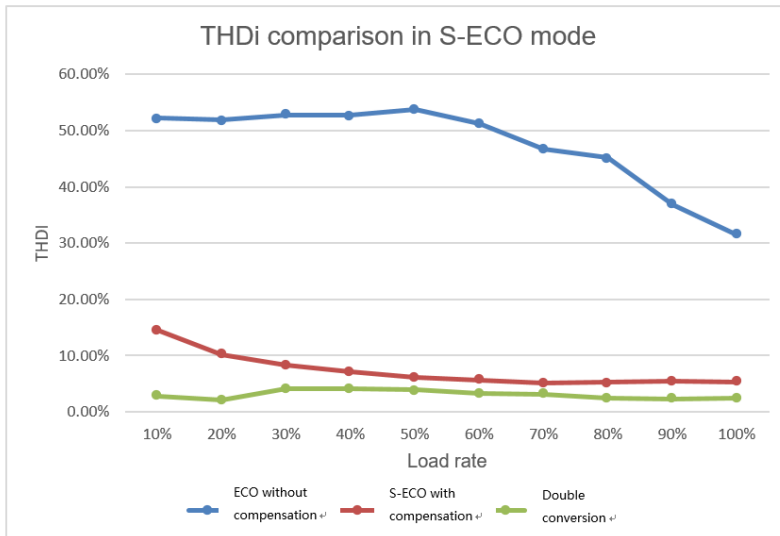
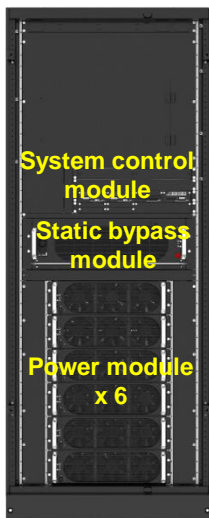

Figure 23 Input THDi comparison for harmonic compensation in S-ECO mode

In the modular transformer-less UPS, the power, control, and bypass module are all hot-swappable, so they can be easily maintained within 5 minutes.



UPS5000-H-600 kVA (door open)



Power module



Bypass module



System control module

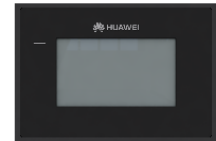

Monitoring display unit

The UPS5000-H uses 100 kVA/3 U modules to achieve the MW power density in a single cabinet, halving the footprint compared with traditional solutions.



100 kVA power module

Huawei: 600 kVA

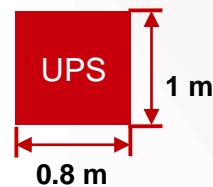

Industry: 1200 kVA

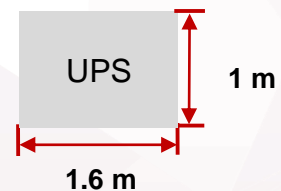

iPower Full-Path Monitoring, Evolving from Passive Alarming to AI-based Predictive Maintenance



Bus capacitor life estimate
Monitoring capacitor **capacity** in real time, predicting the service life one year in advance



Active bypass current equalization
No current sharing inductor required, **current imbalance controlled within 10%** (industry: 30%)

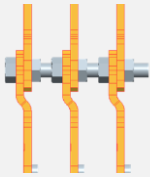

Temperature detection at key nodes
Overtemperature alarm, preventing fire due to disconnection and high temperature



Fan lifespan estimate
Intelligent fan **speed** detection, warning faults one year in advance



The UPS5000-H was tested by third-party authoritative organizations, and all its parameters reached the expected values.

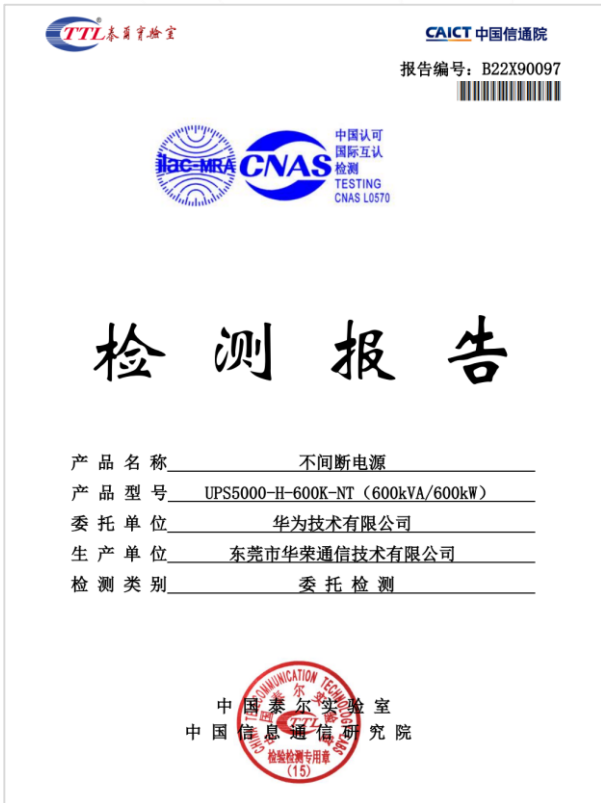

Figure 24 TLC test report for S-ECO mode



Figure 25 TÜV test report for S-ECO mode

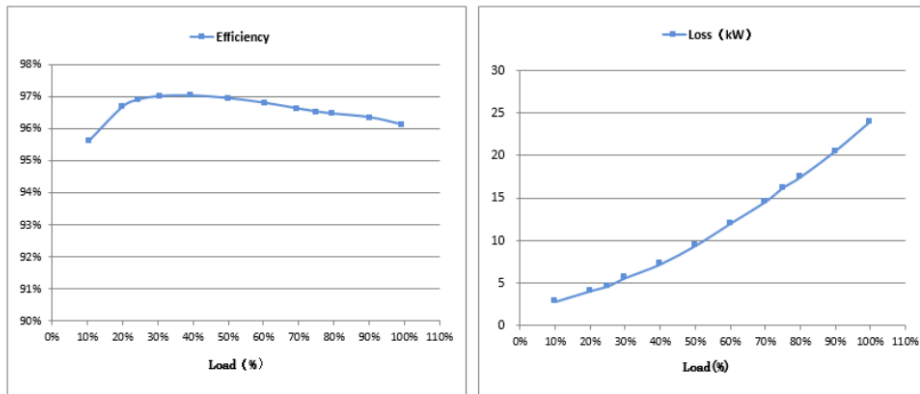

Figure 26 Report excerpt (efficiency test)

Append 19	TABLE 45: - Output transfer in S-ECO mode (Single / Parallel system)	P
Description of test conditions / test construction: Mains input and bypass input share the same power source		
Output transfer interruption time in S-ECO mode: 0ms, and meet the requirements of class 1 curve.		
<ol style="list-style-type: none"> 1) Enable the UPS to operate in S-ECO mode and connect the output to a 100% linear load. Cut Off the input phase A (or three-phase) and UPS transfers to battery mode. Observe the UPS transfer logic and check whether the waveforms of the output voltage and output current are normal during transfer. 2) Recovery bypass, and the UPS transfers to S-ECO mode. Observe the UPS transfer logic and check whether the waveforms of the output voltage and output current are normal during transfer. 3) Enable the UPS to operate in S-ECO mode and connect the output to a 100% non-linear load. Cut Off the input phase A (or three-phase) and UPS transfers to battery mode. Observe the UPS transfer logic and check whether the waveforms of the output voltage and output current are normal during transfer. 4) Recovery bypass, and the UPS transfers to S-ECO mode. Observe the UPS transfer logic and check whether the waveforms of the output voltage and output current are normal during transfer. 5) Repeat the tests above in parallel system 		

Figure 27 Report excerpt (transfer time)

6. FAQs

1. What does S-ECO mean?

S-ECO means super economic operation.

It is an intelligent upgrade of online mode and is as reliable as in online mode and as efficient as in ECO mode.

2. What are the benefits of the S-ECO mode to customers?

The S-ECO mode improves the system efficiency by 3%–4% while ensuring high reliability. It provides four major benefits: 0 ms transfer time between any modes ensures safe power supply, high efficiency in the full load range greatly reduces the PUE; input overvoltage surge suppression and active harmonic compensation compensate for load harmonics.

3. Can batteries be charged as usual in S-ECO mode?

Yes. Batteries are charged through the rectifier and charger. The charging power is the same as that in online double-conversion mode.

4. How much does the S-ECO mode reduce the data center PUE?

According to model calculation, a 1% increase in the UPS efficiency reduces the data center PUE by 0.01. Compared with the common UPS efficiency of 95%–96% in the industry, the PUE can be reduced by 0.03–0.04.

5. How much electricity cost can be reduced in S-ECO mode?

Using a 600 kVA system as an example, the electricity cost can be reduced by about US\$104,480 over its lifetime. (Power: 600 kVA, load rate: 40%; electricity fee: US\$0.12/kWh; actual COP of air conditioners; 3; lifetime: 10 years)

6. Is the S-ECO mode automatically enabled after the UPS starts?

No. The mode needs to be manually set when it is used for the first time. You can retain or change the default values for the bypass input voltage range, bypass input frequency range, active harmonic compensation, and compensation threshold. For details, see section 3.1. After the commissioning is complete, no manual setting or operation is required.

7. Can power grid harmonics be compensated in S-ECO mode?

No. The UPS cannot compensate for power grid harmonics because the power grid capacity is large. When detecting that the power grid harmonics are abnormal, the UPS transfers to online double-conversion mode with 0 ms.

8. Can the S-ECO mode be used if the power grid fails frequently?

Yes. In either online double-conversion mode or S-ECO mode, the UPS transfers to battery mode once the power grid fails. The transfer time is 0 ms.

7. Summary

According to the preceding description and analysis, S-ECO is an innovative working mode of UPS. It has four major benefits: 0 ms transfer time between any modes, high efficiency (up to 99.1%, over 98.5% when the load rate is 20%–100%) in the full load range, high voltage surge suppression, and active harmonic compensation. It solves the problems of interruption and harmonic pollution that exist in the traditional ECO mode, as well as the voltage sag and surge voltage on the power grid side.

The S-ECO mode reduces the data center PUE by 0.03–0.04. It ensures stable and reliable power supply to various loads in data centers and mission-critical power supply in different industries.



Appendix 1

1-1 Settings and Running Status Verification

1-1-1 Parameter Settings and Paths

The UPS parameters to be set include the working mode, harmonic compensation, harmonic compensation output current THD threshold, odd-order harmonic compensation setting, ECO voltage range, and bypass frequency range.

Working mode: The normal mode is used by default. You can set the system to work in S-ECO mode.

Harmonic compensation: This function is enabled by default. If the requirement on power grid harmonics is low but the requirement on system efficiency is high, you can disable this function. In that case, the system does not allow harmonic compensation.

Harmonic compensation output current THD threshold: The value is > 5% by default. The threshold can be customized. Options: > 5%, > 10%, > 20%, and > 30%.

Odd-order harmonic compensation setting: By default, harmonics of odd orders in the range of 1–15 are compensated. You can customize the setting to compensate for a certain order of harmonics.

ECO voltage range: The value is ±5% by default. Options: ±5%, ±6%, ±7%, ±8%, ±9%, and ±10%.

Bypass frequency range: The value is ±2.0 by default. Options: ±0.5, ±1.0, ±2.0, ±3.0, ±4.0, ±5.0, and ±6.0.

On the LCD, choose **System Info > Settings > System Settings**, set **Working mode** to **S-ECO**, and set the operating voltage range and harmonic compensation capability for the S-ECO. After the settings are complete, the S-ECO mode is displayed on the LCD.

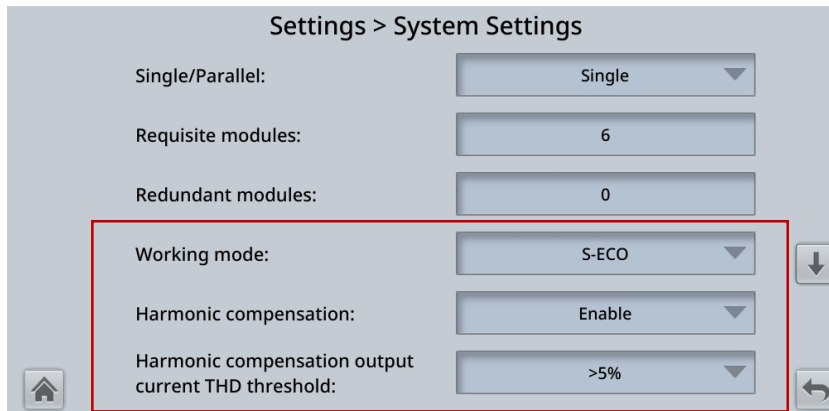

Figure 28 Setting the S-ECO mode (1)

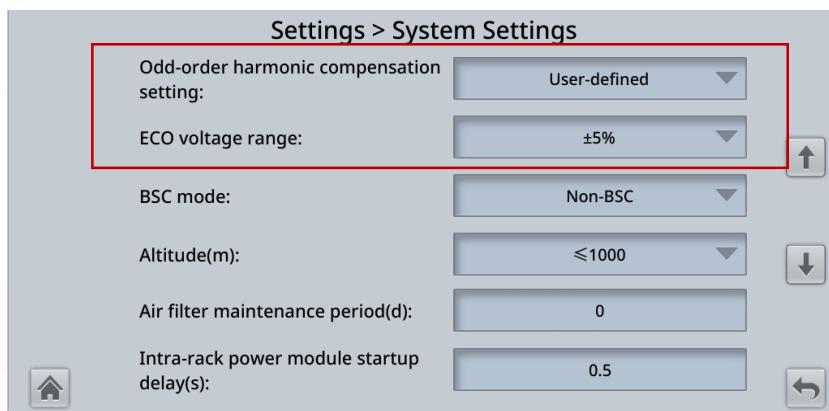

Figure 29 Setting the S-ECO mode (2)

To set the bypass frequency range for the S-ECO mode, choose **System Info > Settings > Bypass Settings** on the LCD.

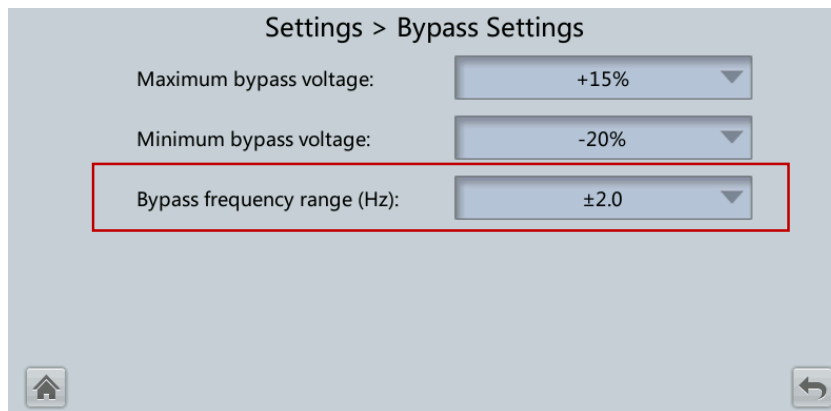

Figure 30 Setting the S-ECO mode (3)



1-1-2 Mode Switching Logic and Running Status Verification

After parameters for the S-ECO mode are set, the UPS preferentially supplies power in bypass mode, calculates the parameters, and adjusts the VFD, VI, and VFI power supply states in real time based on the load rate, load current THDi, load PF, and input voltage frequency. The input voltage, frequency, and THDi parameters need to be manually set on the monitoring screen during initial startup.

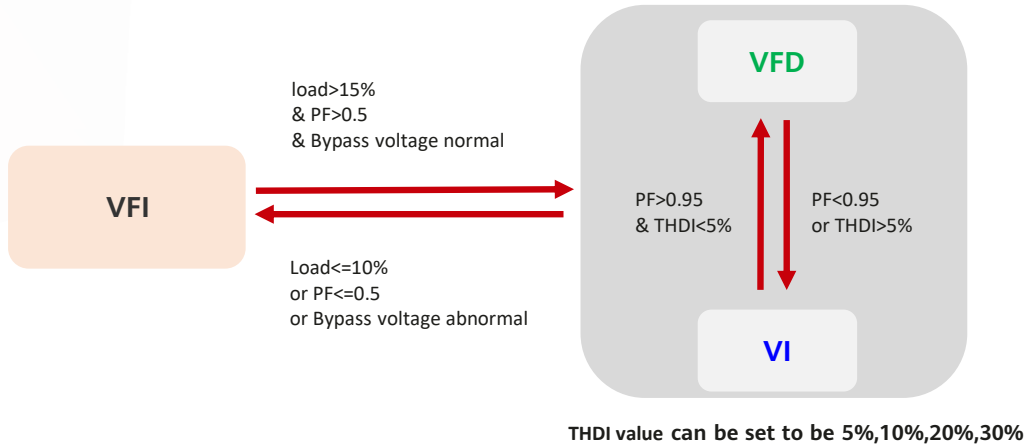

Figure 31 Status switching in S-ECO mode

When the input voltage is good and fluctuates slightly, and the loads are resistive or quasi-resistive, the system works in VFD mode.

Assume that the bypass input voltage frequency is within the preset range, the load current THDi is less than the preset value (5% by default), and the PF is greater than 0.95. The UPS works in VFD mode, the bypass supplies power at efficiency up to 99.1%, and the inverters do not start compensation.

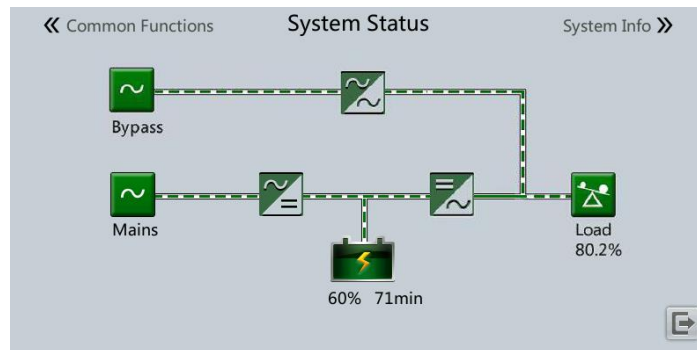

Figure 32 Power flow in S-ECO mode (without harmonic compensation)

When the input voltage is good and fluctuates slightly, and the loads are non-resistive, the system works in VI mode.

Assume that the bypass input voltage frequency is within the preset range, the load current THDi is greater than the preset value (5% by default), and the PF is 0.5–0.95. The UPS automatically enters the VI state, and the inverters compensate for the harmonic and reactive components of the load current, delivering efficiency up to 98.5% while raising the input PF to above 0.99 and reducing the input current THDi to below 5%.

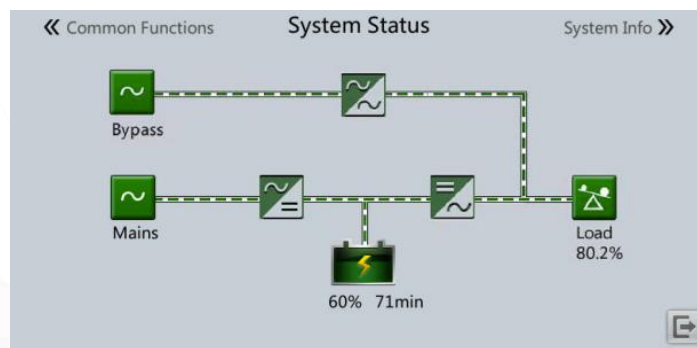

Figure 33 Power flow in S-ECO mode (with harmonic compensation)

When the input voltage is poor and fluctuates greatly, the system runs in VFI state.

If the power grid voltage and frequency exceed the limits, the load PF is less than 0.5, or the load rate is less than 10%, the UPS automatically transfers to normal mode (VFI state) to avoid supplying power of poor waveforms to loads. The UPS monitors the input voltage waveform in real time. When the input voltage becomes normal, the UPS goes back to the VFD or VI state of the S-ECO mode.

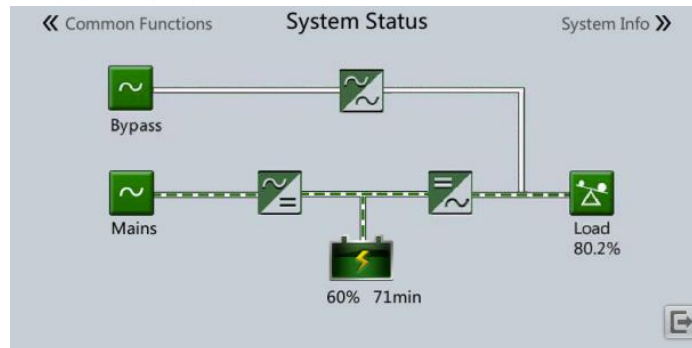

Figure 34 Power flow in S-ECO mode (transfers to online mode)



1-2 Input Adaptability Verification

1-2-1 Input Overvoltage and Undervoltage

The upper limit for the bypass voltage is 10%. If the bypass voltage exceeds the upper limit, the UPS transfers from bypass mode to normal mode with 0 ms, and a bypass voltage abnormality alarm is reported. When the bypass voltage is lower than the upper limit, the alarm is cleared automatically and the UPS transfers from normal mode to bypass mode with 0 ms 5 minutes later.

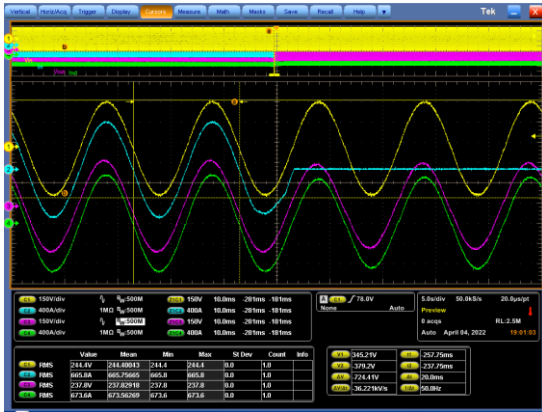

Figure 35 Switching upon overvoltage ($\geq 242\text{ V}$)



Figure 36 Recovery at normal voltage (220 V)

Yellow: bypass input voltage; blue: bypass input current; purple: system output voltage; green: system output current

The lower limit for the bypass voltage is -10% . If the bypass voltage falls below the lower limit, the UPS transfers to normal mode and reports a bypass voltage abnormality alarm. When the bypass voltage is higher than the lower limit, the alarm is cleared automatically and the UPS transfers from normal mode to bypass mode 5 minutes later.

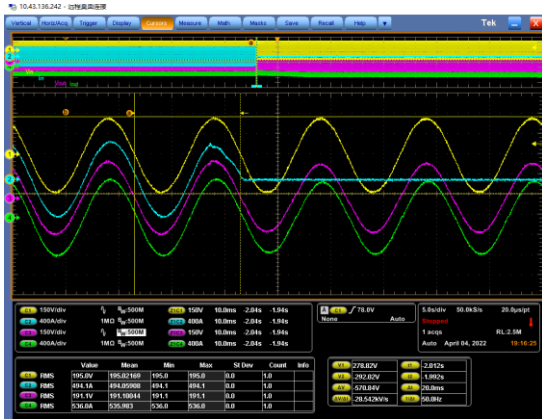

Figure 37 Switching upon undervoltage ($\leq 198\text{ V}$)

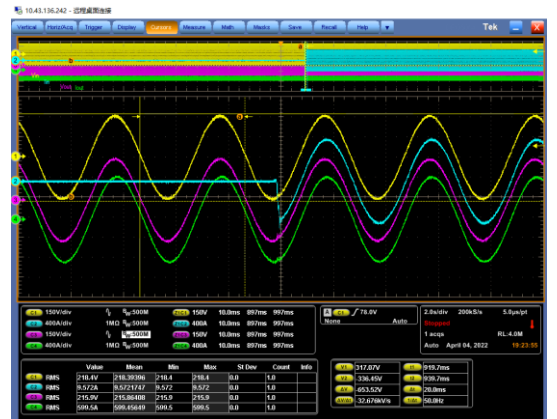

Figure 38 Recovery at normal voltage (220 V)

Yellow: bypass input voltage; blue: bypass input current; purple: system output voltage; green: system output current

1-2-2 Input Overfrequency and Underfrequency

The upper limit for the bypass voltage frequency is 6 Hz. If the bypass voltage frequency exceeds the upper limit, the UPS transfers to normal mode with 0 ms and reports a bypass voltage abnormality alarm. When the bypass voltage frequency is lower than the upper limit, the alarm is cleared automatically and the UPS transfers to bypass mode with 0 ms 5 minutes later.

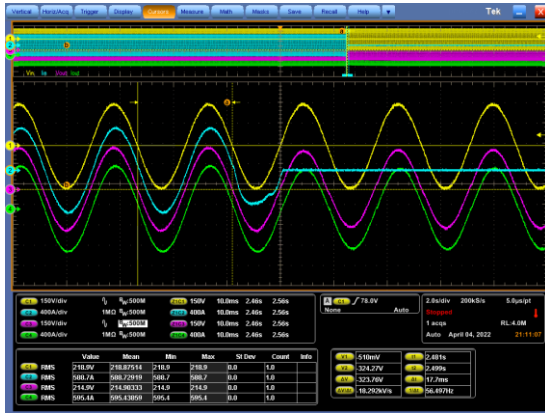

Figure 39 Switching upon overfrequency (≥ 56 Hz)

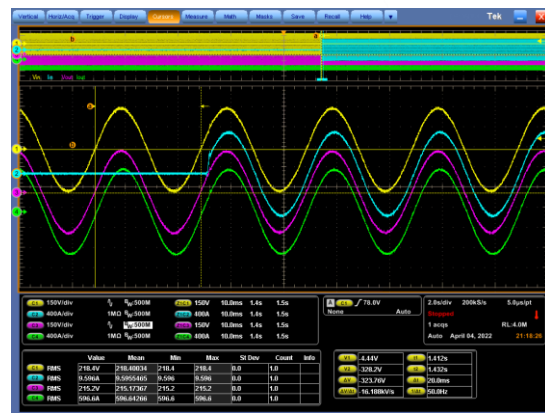

Figure 40 Recovery at normal frequency (50 Hz)

Yellow: bypass input voltage; blue: bypass input current; purple: system output voltage; green: system output current

The lower limit for the bypass voltage frequency is -6 Hz. If the bypass voltage frequency falls below the lower limit, the UPS transfers to normal mode with 0 ms and reports a bypass voltage abnormality alarm. When the bypass voltage frequency is higher than the lower limit, the alarm is cleared automatically and the UPS transfers to bypass mode with 0 ms 5 minutes later.

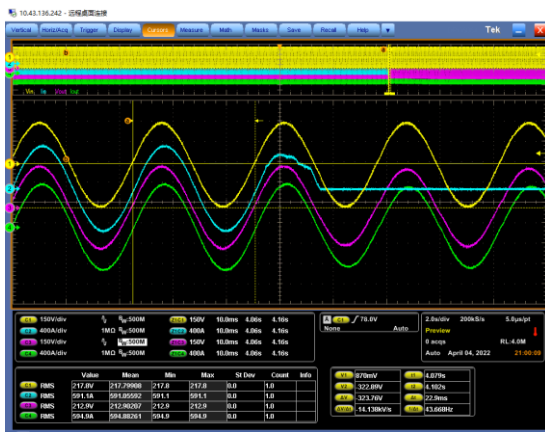

Figure 41 Switching upon underfrequency (≤ 44 Hz)

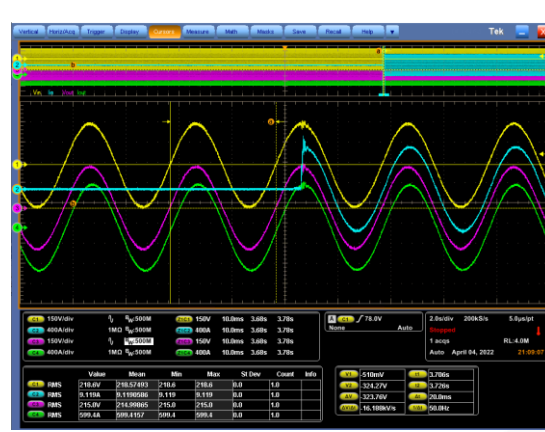

Figure 42 Recovery at normal frequency (50 Hz)

Yellow: bypass input voltage; blue: bypass input current; purple: system output voltage; green: system output current

1-2-3 Input Power Failure

Assume that the output of the UPS in S-ECO mode carries resistive loads and the system works in VFD mode. If the bypass input voltage fails, the system transfers to normal mode with 0 ms and triggers a bypass voltage abnormality alarm. After the bypass voltage recovers, the alarm is cleared automatically. The UPS transfers back to bypass mode with 0 ms 5 minutes later.

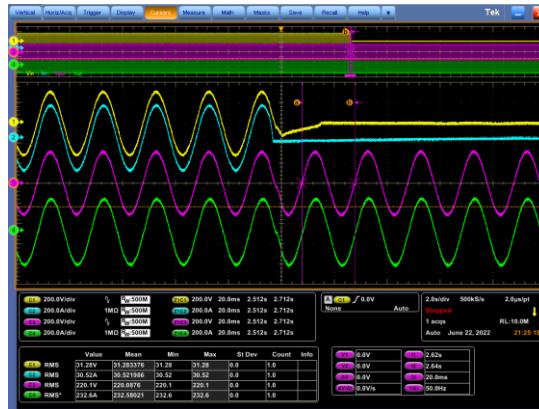

Figure 43 Yellow: bypass input voltage; blue: bypass input current; purple: system output voltage; green: system output current

Assume that the output of the UPS in S-ECO mode carries non-resistive loads and the system works in VI state. If the bypass input voltage fails, the system transfers to normal mode with 0 ms and triggers a bypass voltage abnormality alarm. After the bypass voltage recovers, the alarm is cleared automatically. The UPS transfers back to bypass mode with 0 ms 5 minutes later.



Figure 44 Yellow: bypass input voltage; blue: bypass input current; purple: system output voltage; green: system output current

1-2-4 Input High-Voltage Surge

In S-ECO mode, the UPS suppresses the input high-voltage surge. When a surge voltage of 6 kV in common mode and 6 kV in differential mode exist at the UPS input, the peak value of the residual differential mode voltage at the output can be 0.65 kV and the peak value of the common mode voltage at the output can be 1.93 kV. The differential mode voltage is less than 1 kV and the common mode voltage is less than 2 kV for IT equipment.

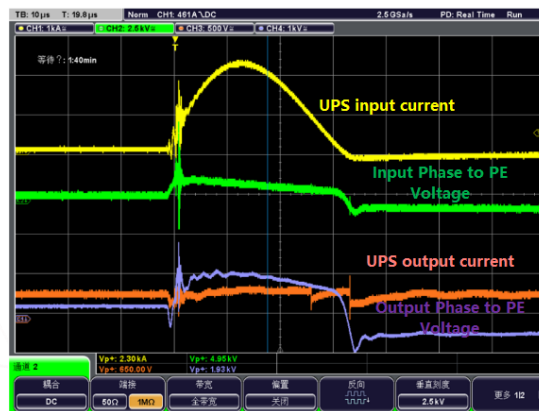

Figure 45 Common-mode 6 kV surge test waveform

1-2-5 Input Voltage Distortion

In S-ECO mode, the UPS monitors the bypass input voltage in real time. If the harmonics increase, the UPS automatically determines that the bypass input is abnormal and transfers to normal mode to ensure good power supply to loads.

During the verification, various harmonic waves (such as triple harmonic, trapezoidal wave, step wave, square wave, spike wave, and triangular wave) are respectively injected into the bypass input. The UPS reports an alarm indicating that the bypass voltage is abnormal and then transfers to inverter mode. The output voltage is not interrupted during the transfer.

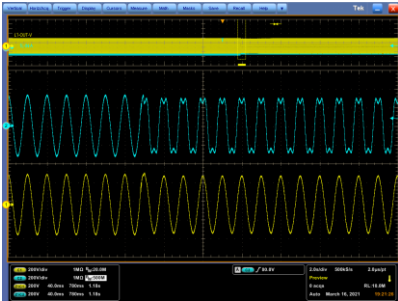

Figure 46 Triple harmonic



Figure 47 Trapezoidal wave



Figure 48 Step wave



Figure 49 Square wave

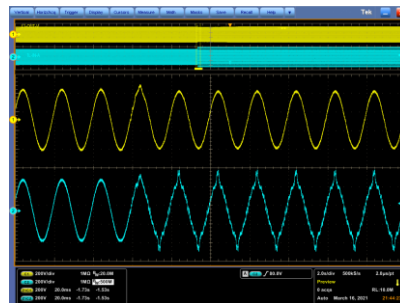

Figure 50 Spike wave



Figure 51 Triangular wave

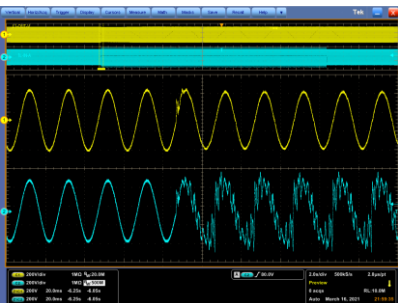

Figure 52 Mining plant waveform 3
(1 kHz 50 V square wave superimposed,
mainly 2nd-, 20th-, and 40th-order harmonics)

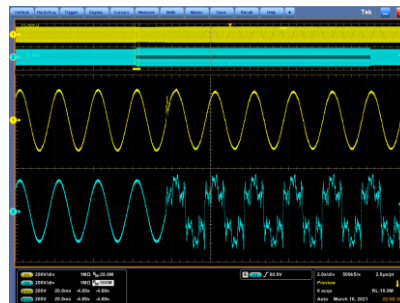

Figure 53 Steel mill waveform 2
(mainly 5th-, 7th-, and 11th-order harmonics)



Figure 54 Chengde waveform
(37th- and 39th-order)

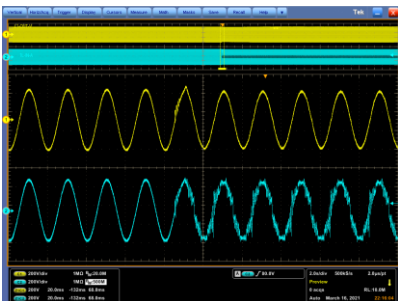

Figure 55 Chengde waveform
(36th- and 38th-order)

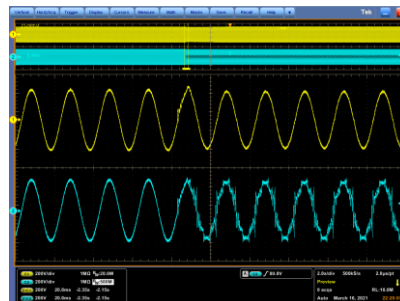

Figure 56 Anshan waveform
(29th- and 31th-order)

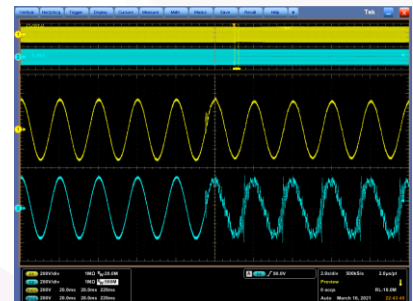

Figure 57 Steel mill waveform 3
(1.5 kHz square wave superimposed)

Blue: input voltage; yellow: output voltage

1-3 Output Adaptability Verification

1-3-1 Active Harmonic Compensation

In S-ECO mode, the UPS performs harmonic compensation based on the load harmonics to reduce the harmonic current on the bypass input, ensuring power grid friendliness. The following figures show the waveforms before and after compensation in S-ECO mode.



Figure 58 Before compensation



Figure 59 After compensation

Yellow: bypass input voltage; blue: bypass input current; purple: system output voltage; green: system output current

In actual tests, when the UPS works in S-ECO mode, the output supplies power to the load whose PF is 0.7. The bypass input PF and THDi after harmonic compensation in S-ECO mode are equivalent to those in dual-conversion mode.

Input power factor comparison (0.7 load power factor) in S-ECO mode

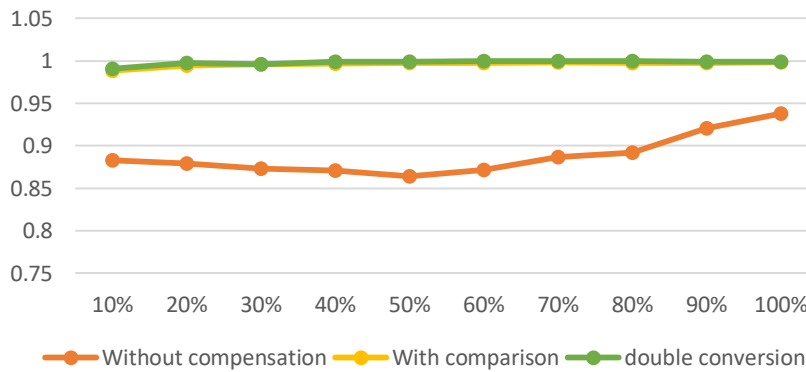

Figure 60 PF comparison for harmonic compensation in S-ECO mode

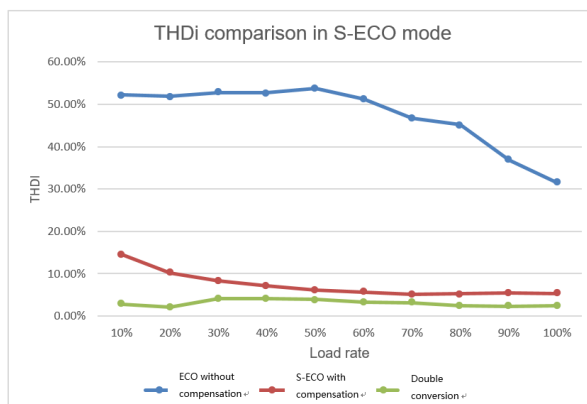

Figure 61 THDi comparison for harmonic compensation in S-ECO mode

1-3-2 Output Dynamic Response

In S-ECO mode, the inverter provides hot backup voltage in real time to ensure that the dynamic response meets the highest standard of class 1 in IEC 62040-3 and that the dynamic change is within 15% after 0.1 ms. During actual tests, the output carries resistive loads, and the system works in VFD state in S-ECO mode. The bypass input voltage fails, and the system transfers to normal mode with 0 ms. The following figure shows the output switching waveform.

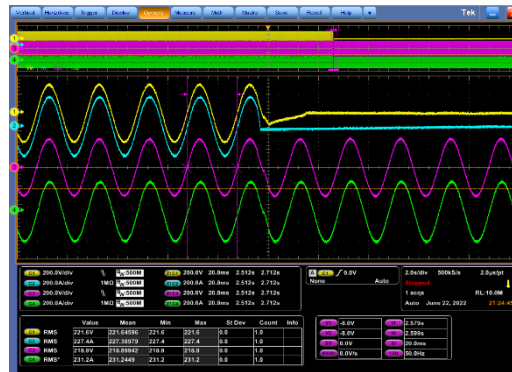

Figure 62 Output dynamic response verification

Yellow: bypass input voltage; blue: bypass input current; purple: system output voltage; green: system output current

According to IEC 62040-3, the dynamic change of the output voltage can be confirmed by using the transient value graphic verification method. The waveform of 0.1 ms to 20 ms after the dynamic change is recorded in real time and compared with the standard waveform, which can be the waveform in a period before the dynamic change occurs). The difference ratio is shown in a standard range curve to check whether the dynamic change meets the requirements.

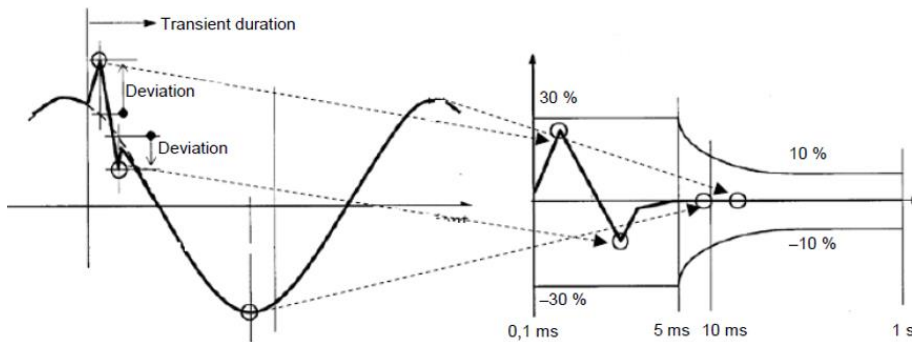

Figure 63 Criteria for UPS output dynamic response

According to the preceding comparison method, the waveforms under testing are converted and analyzed. The analysis result shows that the dynamic change is less than 15% after 0.1 ms.

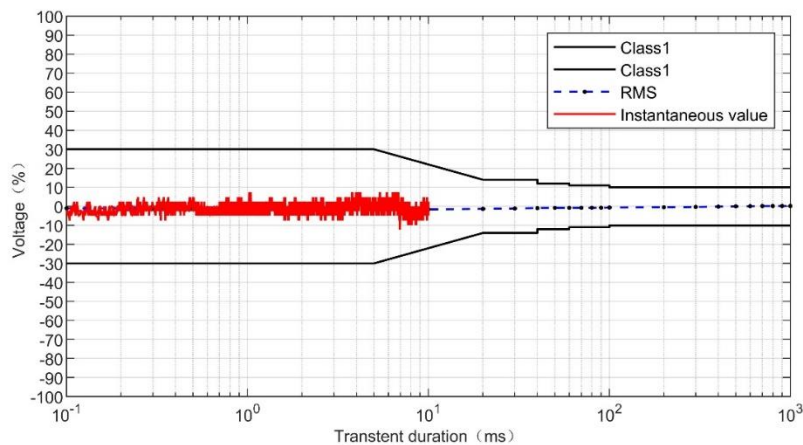

Figure 64 Test result of the dynamic output response of the UPS5000-H in S-ECO mode

1-3-3 Output Short Circuit

When the system works in S-ECO mode, it detects abnormal bypass voltage when an output short-circuit occurs. The system transfers to inverter output, and the inverter output short-circuit lasts for more than 300 ms. If the short circuit is cleared in the inverter output duration, the inverter output recovers and the system transfers back to bypass mode. If the short circuit is not cleared within the inverter output duration, the system transfers to bypass mode and the circuit breaker trips.



Figure 65 Output short circuit

Yellow: bypass input voltage; blue: bypass input current; purple: system output voltage; green: system output current

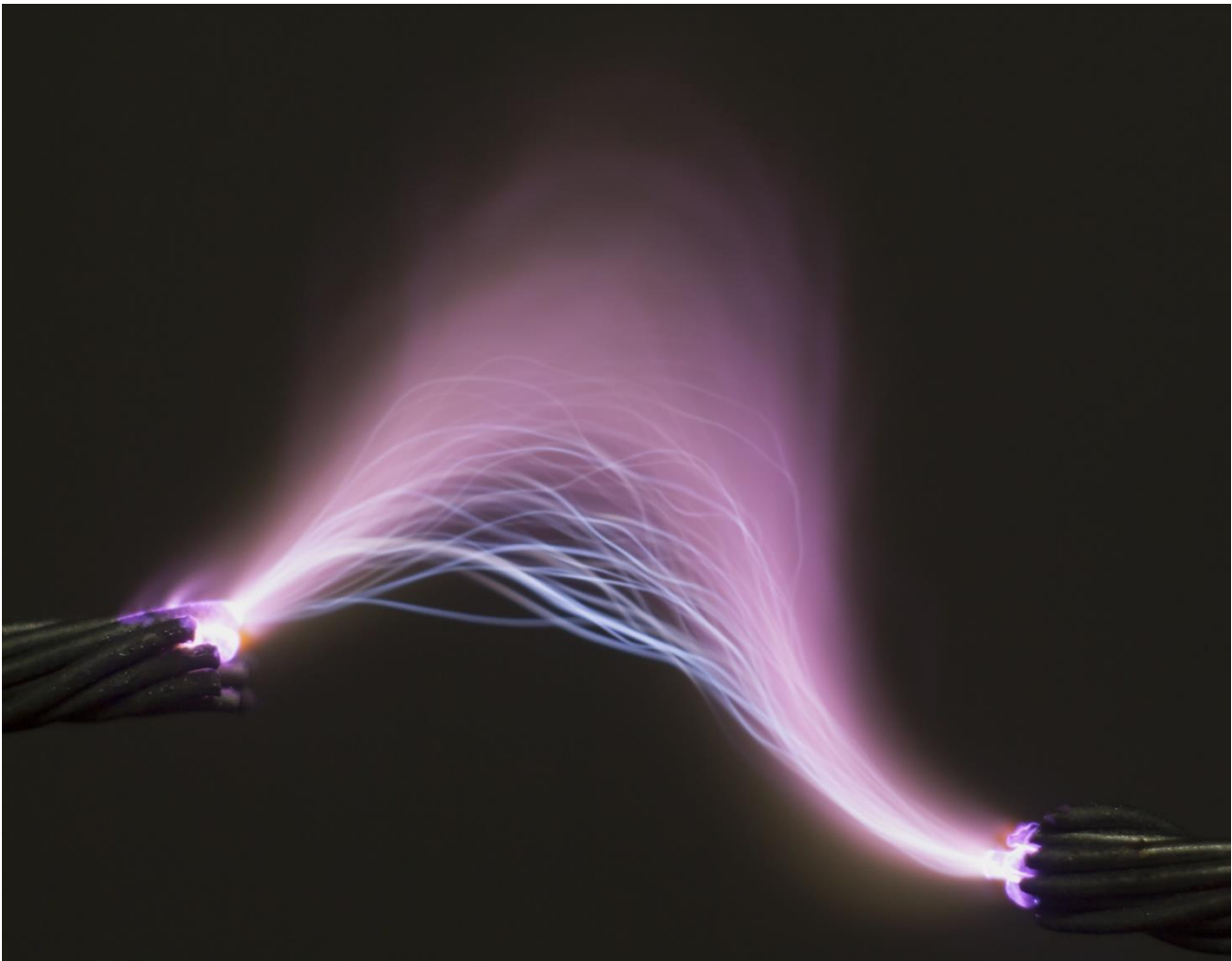



Learn More

Copyright © 2022 Huawei Digital Power Technologies Co., Ltd. All rights reserved.

No part of this document may be reproduced or transmitted in any form or by any means without prior written consent of Huawei Digital Power Technologies Co., Ltd.

Disclaimer

This document may contain predictive information, including but not limited to information about future finance, operations, product series, and new technologies. There are a number of factors that could cause actual results and developments to differ materially from those expressed or implied in the predictive statements. Therefore, such information is provided for reference purposes only, and constitutes neither an offer nor a commitment. Huawei may change the information at any time without notice.

Huawei Digital Power Technologies Co., Ltd.

Huawei Digital Power Antohill Headquarters,
Xiangmihu Futian, Shenzhen 518043, P. R. China

digitalpower.huawei.com